

10
YEARS höfats

PRODUCT CATALOGUE 2025



FIRE. FORM. FUNCTION.

10 YEARS

Only those who are passionate themselves can ignite the fire in others and achieve greatness. That's what höfats is all about – FIRE.

Without an appealing form, function has no stage. It's not just about beautiful form, but the right form – a form that arises from function, complements it, and can be explained through it. Minimalist yet unique. The best form is irreplaceable.

We strive for fascinating functionality. höfats products are astonishingly intuitive, surprise with their multifunctionality, and captivate through the clever use of physical effects. These functionalities are often unique and, to keep them that way, patented.



höfats brings fire into your life. Indoors and outdoors.

We are a dynamic design company in the heart of the Allgäu, developing and distributing fascinating products centered around open fire. Since 2015, our distinctive DNA – fire, form, function – has been delighting fire enthusiasts around the world. In 2025, we proudly celebrate our 10th anniversary – a journey full of passion and innovation that has accompanied us and our customers for a decade.

Our mission is both simple and profound: We want to create the perfect ambiance for your unforgettable moments by the fire, because is there anything more beautiful than gathering with friends around a crackling fire? To make these moments special, we invent, develop, and produce products that are as unique and beautiful as they are functional.

Our collection includes tabletop fireplaces, fire bowls, grills, and candleholders – and is constantly evolving. Every höfats product combines minimalist design, ingenious functionality, and premium materials to ensure that your time by the fire becomes the best of your life.

Our pursuit of excellence has earned us over 50 international design awards, including the most prestigious accolades in the industry. From the living room to the great outdoors – höfats brings the timeless allure of fire to every moment.





16



20



24



26



28



6



SPIN



MOON

40

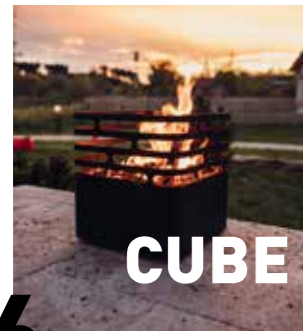

CUBE



TRIPLE



BEER BOX



ELLIPSE



CONE

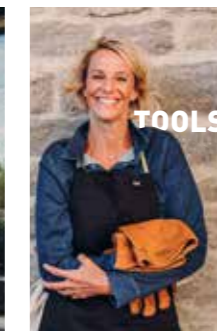

TOOLS



64

46



50



54



58



60





SPIN

The wild vortex of flames in the decorative glass cylinder

creates a unique flame display that turns any occasion into an unforgettable experience. It impresses with unparalleled aesthetics, thoughtful functionality, and uncompromising safety – honored with numerous prestigious design awards.

Fueled by natural höfats bioethanol, the striking flame rises dynamically with the placement of the heat-resistant borosilicate glass cylinder, radiating a comforting warmth in all directions. Always securely enclosed within the glass cylinder, the flame burns odorless, soot-free, and smokeless, and is certified to the highest standards (DIN EN 16647) for both indoor and outdoor enjoyment. When the spectacle needs to end, the included extinguishing lid ensures the flame is safely and easily put out.

Available in three models with various materials, colors, and sizes, SPIN can be flexibly expanded into a garden torch, standing, or hanging fire. SPIN infuses modern living spaces with the enchanting magic of fire – stylish, versatile, and captivating.

Certified for indoor use

Breathtaking flame display

Pleasant warmth

Burns soot- and smoke-free (Bioethanol)



OVERVIEW OF ALL SPIN MODELS



SPIN 90 | 120

- FLAME**
 - ✓ Spectacular whirl of flames
 - ✗ Structured flame even in daylight
 - ✗ Patented Bio-Burner burner technology
- FUEL**
 - ✓ Biological gel fuel
 - ✗ Price advantage of liquid fuel
- BURNING TIME**
 - SPIN 90: 60 min
 - SPIN 120: 80 min
- FUNCTION**
 - ✓ Radiates pleasant warmth
 - ✓ Certified for indoor and outdoor use
 - ✓ Burns odorless, soot-free and smokeless
 - ✗ Burner with protective valve
 - ✗ Option to extend the burning time (eco-ring)
- VARIATION**
 - ✗ Available in different colours
 - ✗ Available in different materials
 - ✓ Classic Look
 - ✓ Expandable as a hanging fire and torch

SPIN 900 | 1200 | 1500

- FLAME**
 - ✓ Spectacular whirl of flames
 - ✓ Structured flame even in daylight
 - ✓ Patented Bio-Burner burner technology
- FUEL**
 - ✓ Biological liquid fuel
 - ✓ Price advantage of liquid fuel
- BURNING TIME**
 - SPIN 900: up to 2 h
 - SPIN 1200: up to 2,5 h
 - SPIN 1500: up to 2,5 h
- FUNCTION**
 - ✓ Radiates pleasant warmth
 - ✓ Certified for indoor and outdoor use
 - ✓ Burns odorless, soot-free and smokeless
 - ✓ Burner with protective valve
 - ✓ Option to extend the burning time (eco-ring)
- VARIATION**
 - ✓ Available in different colours
 - ✗ Available in different materials
 - ✓ Classic Look
 - ✓ Expandable as a hanging fire and torch

SPIN air 900 | 1200

- FLAME**
 - ✓ Spectacular whirl of flames
 - ✓ Structured flame even in daylight
 - ✓ Patented Bio-Burner burner technology
- FUEL**
 - ✓ Biological liquid fuel
 - ✓ Price advantage of liquid fuel
- BURNING TIME**
 - SPIN air 900: up to 2h
 - SPIN air 1200: up to 2,5h
- FUNCTION**
 - ✓ Radiates pleasant warmth
 - ✓ Certified for indoor and outdoor use
 - ✓ Burns odorless, soot-free and smokeless
 - ✓ Burner with protective valve
 - ✓ Option to extend the burning time (eco-ring)
- VARIATION**
 - ✓ Available in different colours
 - ✓ Available in different materials
 - ✓ Slim Look
 - ✗ Expandable as a hanging fire and torch

SPIN *air* 900 | 1200

COLOURS | MATERIALS

BASE steel casting **WING BODY** plastic **GLASS CYLINDER** borosilicate glass

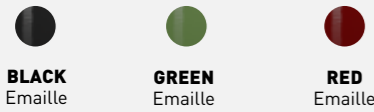

SPIN air 900 | 1200 TABLETOP FIREPLACE – The fusion of the primal with the modern. With supreme quality and exceptional materials, the award-winning flame vortex sets stylish accents and brings the magic of fire into the modern lifestyle. Whether in the living room or on the balcony, SPIN air is the perfect addition to any interior, adding an extra touch of sophistication to refined taste.

- Modern slim look in various colors
- Utilizes the patented Bio-Burner with innovative burner technology
- Burn time per filling: 80–120 minutes with 250 ml (SPIN air 900), 100–150 minutes with 500 ml (SPIN air 1200)
- Heat output: 1100 W (SPIN air 900), 2000 W (SPIN air 1200)
- Fuel: höfats liquid bioethanol
- Included in delivery: base, wing body, Bio-Burner with Eco-Ring and extinguishing lid, glass cylinder

SPIN air 1200 Tabletop Fireplace
 Base: Ø 14 cm, glass cylinder: Ø 12 cm, 54 cm height mounted, 3.1 kg | gross: 68 x 17.5 x 17.5 cm, 3.9 kg
SPIN air 1200 Emaille black Item no. 00777, EAN 4064251007771
SPIN air 1200 Emaille green Item no. 00819, EAN 4064251008198
SPIN air 1200 Emaille rot Item no. 00814, EAN 4064251008143

SPIN air 900 Tabletop Fireplace
 Base: Ø 11 cm, glass cylinder: Ø 9.5 cm, 40.5 cm height mounted, 1.7 kg | gross: 51.5 x 14.5 x 14.5 cm, 2 kg
SPIN air 900 Emaille black Item no. 00776, EAN 4064251007764
SPIN air 900 Emaille green Item no. 00818, EAN 4064251008181
SPIN air 900 Emaille rot Item no. 00813, EAN 4064251008136



SPIN air 900 | 1200 BUILT-IN – The SPIN flame vortex in a built-in version offers maximum flexibility for creative fire installations. Without a base, SPIN can be seamlessly integrated into custom objects or surfaces – whether it's a table, a stone slab, or a custom enclosure. All that's needed is a precisely fitting hole to securely insert the wing body with the Bio-Burner and enjoy the mesmerizing flame display. This creates a unique design highlight, where the iconic flame vortex provides a soot- and smoke-free ambiance, combining individuality with functionality to create a captivating atmosphere.

- Custom Integration of the SPIN flame vortex into chosen surfaces or furniture pieces
- Ideal for use on tables, stone slabs, or custom enclosures
- Utilizes the patented Bio-Burner with innovative burner technology
- Burn time per filling: 100–150 minutes with 500 ml
- Heat output: 2000 W
- Fuel: höfats liquid bioethanol
- Scope of delivery: Wing body, Bio-Burner with Eco-Ring and extinguishing lid, glass cylinder

SPIN air 1200 Built-in black
 Base: Ø 12.5 cm, glass cylinder: Ø 12 cm, 53.5 cm height assembled, 1.6 kg | Packing dimensions: 68 x 17.5 x 17.5 cm, 2.6 kg
 Item no. 00975, EAN 4064251009751

SPIN 900 | 1200 | 1500



COLOURS | MATERIALS

HOUSING stainless steel **GLASS CYLINDER** borosilicate glass

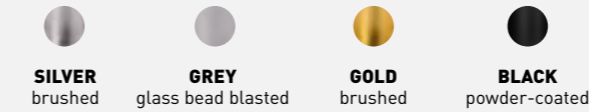

SPIN 900 | 1200 | 1500 TABLETOP FIREPLACE – The captivating flame display, enhanced with the technologically advanced Bio-Burner, absorbs the liquid höfats bioethanol within its core, allowing the distinctive flame to rise like a sculpture. Featuring a strikingly textured flame, whose burn time can be increased by an additional 50% with the optional Eco-Ring, the SPIN 900 | 1200 | 1500 guarantees even more enjoyment at any time of day.

- Utilizes the patented Bio-Burner with innovative burner technology
- Optional expansion into a garden torch, hanging fire, or standing fire
- Burn time with one filling: 80 - 120 min with 250ml (SPIN 900), 100 - 150 min with 500 ml (SPIN 1200), 100 - 150 min with 1000 ml (SPIN 1500)
- Heat output: 1100 W (SPIN 900), 2000 W (SPIN 1200), 3800 W (SPIN 1500)
- Fuel: höfats liquid bioethanol
- Included in delivery: base, wing body, Bio-Burner with Eco-Ring and extinguishing lid, glass cylinder

German Design Award 2021
 Iconic Award "Innovative Interior" 2020
 ambiente solutions 2020
 European Product Design Award 2019
 Red Dot Design Award Winner 2019

SPIN 1500 Tabletop Fireplace
 Base: Ø 29 cm, glass cylinder: Ø 15 cm, 67 cm height mounted, 7 kg
 gross 30 x 41 x 77 cm, 11.5 kg
SPIN 1500 Tabletop Fireplace silver Item no. 00509, EAN 4064251005098
SPIN 1500 Tabletop Fireplace black Item no. 00628, EAN 4064251006286

SPIN 1200 Tabletop Fireplace
 Base: Ø 23 cm, glass cylinder: Ø 12 cm, 54 cm height mounted, 4.3 kg
 gross 24,5 x 21,5 x 70 cm, 6.5 kg
SPIN 1200 Tabletop Fireplace silver Item no. 00695, EAN 4064251006958
SPIN 1200 Tabletop Fireplace grey Item no. 00697, EAN 4064251006972
SPIN 1200 Tabletop Fireplace gold Item no. 00699, EAN 4064251006996
SPIN 1200 Tabletop Fireplace black Item no. 00700, EAN 4064251007009

SPIN 900 Tabletop Fireplace
 base: Ø 19 cm, glass cylinder: Ø 9 cm, 40.5 cm height mounted, 2.6 kg
 gross 20 x 16 x 52,5 cm, 4 kg
SPIN 900 Tabletop Fireplace silver Item no. 00691, EAN 4064251006910
SPIN 900 Tabletop Fireplace grey Item no. 00690, EAN 4064251006903
SPIN 900 Tabletop Fireplace gold Item no. 00692, EAN 4064251006927
SPIN 900 Tabletop Fireplace black Item no. 00693, EAN 4064251006934



SPIN 900 | 1200 HANGING FIRE – The fire takes flight, appearing to float effortlessly in the space. As a hanging fire, SPIN can be suspended from a sturdy yet elegant stainless steel wire using a hook. Flexibly adjustable in height, SPIN becomes an impressive eye-catcher, whether indoors or outdoors.

- Suitable for use as a hanging fire both indoors and outdoors
- Suspended with a stainless steel wire, height-adjustable
- Easy screw mounting without the need for tools
- Included in delivery: hanging system, wing body, Bio-Burner with Eco-Ring and extinguishing lid, glass cylinder

SPIN 1200 Hanging Fire silver
 Glass cylinder: Ø 12 cm, Hanging Fire: 16x12x79 cm, 2.5 kg,
 wire length: 60-120 cm
 gross 80 x 25 x 18 cm, 3.2 kg
 Item no. 00834, EAN 4064251008341

SPIN 900 Hanging Fire silver
 Glass cylinder: Ø 9 cm, Hanging Fire: 13 x 9 x 60 cm, 1.2 kg,
 wire length: 60-120 cm
 gross 62 x 19 x 13,5 cm, 2.1 kg
 Item no. 00833, EAN 4064251008334

SPIN 90 | 120



COLOURS | MATERIALS

HOUSING stainless steel **GLASS CYLINDER** borosilicate glass



SILVER
brushed



SPIN 90 | 120 TABLETOP FIREPLACE – The iconic wild flame vortex in a decorative glass cylinder brings the finest campfire atmosphere to your living room, balcony, or terrace. Simply insert the gel fuel container into the wing body, ignite, and enjoy the radiant flame vortex for 60–80 minutes.

- ☆ **Cost-effective SPIN model with gel fuel cup**
- **Optional expansion into a garden torch, hanging fire, or standing fire**
- **Burn time per filling: 60 minutes with 225 ml (SPIN 90), 80 minutes with 500 ml (SPIN 120)**
- **Heat output: 1200 W (SPIN 90), 2500 W (SPIN 120)**
- **Fuel: höfats bioethanol gel fuel**
- **Scope of delivery: base, wing body, gel fuel cup, extinguishing lid, glass cylinder**

- ✂ German Design Award 2021
- Iconic Award "Innovative Interior" 2020
- ambiente solutions 2020
- European Product Design Award 2019
- Red Dot Design Award Winner 2019

📦 **SPIN 120 Tabletop Fireplace silver**
Base: Ø 23 cm, glass cylinder: Ø 12 cm, 54 cm height mounted, 4.3 kg
gross 24 × 21 × 69 cm, 5.6 kg
Item no. 00024, EAN 4064251000246

📦 **SPIN 90 Tabletop Fireplace silver**
Base: Ø 19 cm, glass cylinder: Ø 9 cm, 40.5 cm height mounted, 2.6 kg
gross 20 × 16,5 × 50,5 cm, 3,7 kg
Item no. 00046, EAN 4064251000468



SPIN GEL FUEL CUP - The economical gel fuel cup ensures that the fire never goes out. As soon as it has cooled down, it can be filled again with the höfats gel fuel and the flame experience can continue.

- ☆ **sustainable and economical gel fuel cup**
- **capacity: 225 ml (SPIN 90), 500 ml (SPIN 120)**
- **for use with höfats bioethanol**
- **integrated level indicator**
- **stainless steel**

📦 **SPIN 120 Gel Fuel Cup**
Ø 8.5 cm, 9.5 cm height, 0.13 kg | gross 9 × 9 × 10 cm, 0.16 kg
Item no. 00023, EAN 4064251000239

📦 **SPIN 90 Gel Fuel Cup**
Ø 6 cm, 8 cm height, 0.07 kg | gross 7 × 7 × 8 cm, 0.1 kg
Item no. 00045, EAN 4064251000451

FUELS SPIN

COMPATIBLE WITH
SPIN 900 | 1200 | 1500
SPIN air 900 | 1200



BIOETHANOL LIQUID FUEL – The original höfats bioethanol liquid fuel is made from renewable raw materials and provides the perfect flame experience for all SPIN tabletop fireplaces with Bio-Burner. Odourless, smoke-free and organic, you can enjoy the warmth of the fire in complete safety and with a clear conscience and let your balcony, terrace, living room or dining table shine in atmospheric light.

- ☆ **Safe, natural, sustainable, odourless and smokeless fuel**
- **1 l bioethanol liquid fuel per bottle**
- **Use only for the SPIN air 900 | SPIN air 1200, SPIN 900 | 1200 | 1500 and all retrofitted Bio-Burners 900 | 1200 | 1500**
- **Safety gel fuel according to Regulation (EC) No 1907/2006 (REACH)**

📦 **Bioethanol Liquid Fuel 6 pack**
Ø 9 cm, 27 cm Height, 0.9 kg | gross 26 × 18 × 28 cm, 5.2 kg
Item no. 00525, EAN 4064251005258

COMPATIBLE WITH
SPIN 90 | 120



BIOETHANOL GEL FUEL – Odourless, smokeless and organic: The original höfats SPIN bioethanol gel fuel made from thickened alcohol is produced from renewable raw materials and enables the perfect SPIN flame experience.

- ☆ **Safe, natural, sustainable, odourless and smokeless fuel**
- **For filling the SPIN 90 | 120 gel fuel cup**
- **1 l bioethanol gel fuel per bottle**
- **Safety gel fuel according to Regulation (EC) No 1907/2006 (REACH)**

📦 **BIOETHANOL FUEL GEL BOTTLE 6 PACK** Ø 7.5 cm, 26 cm height, 1 kg | gross 25.2 × 16.9 × 27 cm, 5.7 kg
Item-No. 090801-6, EAN 4260447331167

ACCESSORIES SPIN

COMPATIBLE WITH SPIN 90 | 120 & SPIN 900 | 1200 | 1500

COMPATIBLE WITH
SPIN 90 | 120 &
SPIN 900 | 1200 | 1500

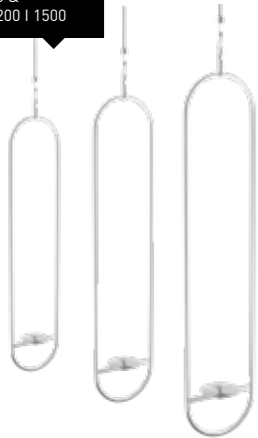

SPIN HANGING SYSTEM – With the hanging system, SPIN becomes a hanging fire that can be suspended from the stable yet elegant stainless steel wire, attached to a hook and flexibly adjusted in height. SPIN seems to float effortlessly in space and becomes an impressive eye-catcher, whether indoors or outdoors.

- Enables use of SPIN 90 | 120 and SPIN 900 | 1200 | 1500 as a hanging fire
- Indoor and outdoor use
- Suspension by stainless steel wire, height adjustable
- Easy screw mounting without tools
- Stainless steel, brushed

SPIN 1500 Hanging System silver
11 x 19 x 97 cm, 1 kg, Wire length: 60–120 cm
gross 13 x 21 x 100 cm, 1.8 kg
Item no. 00774, EAN 4064251007740

SPIN 1200 Hanging System silver
16 x 8,5 x 79 cm, 1.2 kg, Wire length: 60–120 cm
gross 62 x 19 x 13.5 cm, 2.1 kg
Item no. 00308, EAN 4064251003087

SPIN 900 Hanging System silver
13 x 6 x 60 cm, 0.4 kg, Wire length: 60–120 cm
gross 62 x 12,5 x 8 cm, 0.6 kg
Item no. 00312, EAN 4064251003124

COMPATIBLE WITH
SPIN 90 | 120 &
SPIN 900 | 1200 | 1500



SPIN STAND ELEVATION – Thanks to the stand elevation, SPIN works even better on the ground. Mounted easily and without tools between base and wing body, the SPIN flame lifts by 9 cm (SPIN 90 | 900), 11 cm (SPIN 120 | 1200) or 14 cm (SPIN 1500).

- For using the tabletop fireplace on the floor
- Elevates SPIN by 9 cm (SPIN 90 | 900), 11 cm (SPIN 120 | 1200) or 14 cm (SPIN 1500)
- Only for outdoor use
- Maximum stability is maintained
- Easy screw mounting without tools
- Stainless steel

SPIN 1500 Stand Elevation silver
Ø 11,5 cm, 15 cm height, 0.5 kg | gross 12.5 x 12.5 x 16.5 cm, 0.7 kg
Item no. 00629, EAN 4064251006293

SPIN 1500 Stand Elevation black
Item no. 00630, EAN 4064251006309

SPIN 1200 Stand Elevation silver
Ø 9 cm, 11.5 cm Height, 0.27 kg | gross 9.5 x 9.5 x 12.5 cm, 0.3 kg
Item no. 00013, EAN 4064251000130

SPIN 1200 Stand Elevation grey
Item no. 090201, EAN 4260447330917

SPIN 1200 Stand Elevation gold
Item no. 00012, EAN 4064251000123

SPIN 1200 Stand Elevation black
Item no. 00011, EAN 4064251000116

SPIN 900 Stand Elevation silver
Ø 6.5 cm, 9 cm Height, 0.16 kg | gross 7 x 7 x 9.5 cm, 0.9 kg
Item no. 00040, EAN 4064251000406

SPIN 900 Stand Elevation grey
Item no. 00222, EAN 4064251002226

SPIN 900 Stand Elevation gold
Item no. 00039, EAN 4064251000390

SPIN 900 Stand Elevation black
Item no. 00038, EAN 4064251000383

COMPATIBLE WITH
SPIN 90 | 120 &
SPIN 900 | 1200 | 1500



SPIN BASE – If the SPIN torch or the SPIN hanging fire is to stand freely, the solid SPIN base can be mounted and the SPIN can thus be placed on any table. Likewise, the ground spike can be placed on solid ground outdoors when mounting the SPIN 1200 Base.

- Enables the use of the garden torch or hanging fire as a tabletop fireplace
- Enables positioning of the SPIN 90 | 120 and SPIN 900 | 1200 garden torch on solid ground (only with SPIN 1200 Base, Ø 23 cm, outdoor only)
- Stainless steel

SPIN 1500 Base (ONLY SPARE PART)
Ø 29 cm, 1.1 cm Height, 4.3 kg | gross 30 x 30 x 1.5 cm, 4.5 kg
Item no. 00634, EAN 4064251006347

SPIN 1500 Base black
Item no. 00637, EAN 4064251006378

SPIN 1200 Base silver
Ø 23 cm, 1.1 cm Height, 2.78 kg | gross 23.5 x 23.5 x 2 cm, 2.85 kg
Item no. 00007, EAN 4064251000079

SPIN 1200 Base grey
Item no. 00161, EAN 4064251001618

SPIN 1200 Base gold
Item no. 00006, EAN 4064251000062

SPIN 1200 Base black
Item no. 00005, EAN 4064251000055

SPIN 900 Base silver
Ø 19 cm, 1 cm Height, 1.87 kg | gross 19.5 x 19.5 x 1.5 cm, 1.92 kg
Item no. 00028, EAN 4064251000284

SPIN 900 Base grey
Item no. 00223, EAN 4064251002233

SPIN 900 Base gold
Item no. 00027, EAN 4064251000277

SPIN 900 Base black
Item no. 00026, EAN 4064251000260

COMPATIBLE WITH
SPIN 90 | 120 &
SPIN 900 | 1200 | 1500



GROUND SPIKE – With the ground spike as an accessory, SPIN can be transformed into a garden torch in no time at all. Simply stuck into the lawn, flower bed or flower pot or screw onto the base, it will enchant guests at the next garden party and become the eye-catcher of the evening. Thanks to the three different length components of the ground spike (17 cm + 34 cm + 48 cm), the SPIN can be raised to the desired height and securely anchored in the ground via the additional ground spike.

- Enables use of SPIN 90 | 900 | 120 | 1200 as a garden torch
- Variable height thanks to three-part ground spike
- Easy screw mounting without tools
- Is inserted into the ground via the ground spike
- Can also be mounted on the SPIN 1200 Base as a foot on solid ground
- Only for outdoor use
- Stainless steel

Ground Spike silver
Ø 1.5 cm, 124 cm height, 0.39 kg | gross 49 x 5.5 x 2 cm, 0.5 kg
Item no. 00002, EAN 4064251000024

ACCESSORIES SPIN, SPIN air

COMPATIBLE WITH ALL SPIN MODELS

COMPATIBLE WITH ALL
SPIN MODELS



SPIN BIO-BURNER – The central element of the popular flame play enchants all SPIN lovers with a spectacular flame experience. Enjoy a striking and brightly glowing flame that rises like a sculpture at any time of day or night, indoors or out. The technologically advanced bio-burner is 100% com-patible with SPIN 90 | 120 and impresses with its sophisticated functionality, uncompromising safety and a significantly longer burning time with the same amount of bioethanol liquid fuel. Odourless, soot-free and smoke-free, you can enjoy the warmth of the fire and, with the additional Eco-Ring, the burning time can be extended by another 50%.

- Patented Bio-Burner with innovative burner technology
- Can replace the gel fuel cup of SPIN 90 | 120 and thus upgrade SPIN 90 | 120 to SPIN 900 | 1200
- Capacity: 250 ml (SPIN 900), 500 ml (SPIN 1200) 1000 ml (SPIN 1500)
- Burn time with one filling: 80–120 min (SPIN 900), 100–150 min (SPIN 1200)
- Burn time can be increased by 50% with Eco-Ring
- Bio-Burner is filled with liquid bioethanol via protection valve
- Only for use with höfats bioethanol liquid fuel
- Scope of delivery Bio-Burner 900 | 1200: Bio-Burner, Eco-Ring, extinguishing lid

SPIN 1200 Bio-Burner
Ø 8,7 cm, 10.5 cm height, 0.3 kg | gross 12 x 13 x 12 cm, 0.4 kg
Item no. 00696, EAN 4064251006965

SPIN 900 Bio-Burner
Ø 6,5 cm, 7,8 cm height, 0.17 kg | gross 9,5 x 9,5 x 9,5 cm, 0.25 kg
Item no. 00689, EAN 4064251006897

COMPATIBLE WITH ALL
SPIN MODELS



SPIN COVER – The perfect cover for safe storage of SPIN and SPIN air. The drawstring ensures a secure fit, while the water-repellent material protects against dirt and moisture.

- Perfectly fitting protective cover
- With drawstring for secure fastening
- Hard-wearing polyester-nylon blend fabric
- Water-repellent
- Suitable for all SPIN and SPIN air models

SPIN 1500 Cover
gross: 2.9 x 31 cm, 0.2 kg
Item no. 00638, EAN 4064251006385

SPIN 1200 Cover
27.5 x 25.5 x 3 cm
gross: 23.5 x 27.5 cm, 0.2 kg
Item no. 00375, EAN 4064251003759

SPIN 900 Cover
23 x 21 x 2.5 cm
gross: 21 x 23 cm, 0.2 kg
Item no. 00377, EAN 4064251003773

OVAL CANDLE



OVAL CANDLE 35 | 55

COLOURS | MATERIALS

HOUSING stainless steel **GLASS CYLINDER** borosilicate glass

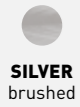

SILVER
brushed



BLACK
brushed

1 product, 2 variations:
standing or hanging

Removable wax drip tray
for easy cleaning

Lid as heat protection and
flame extinguishing

Safe stand for
conventional candles



OVAL CANDLE 35 – A declaration of love to the long oval. Timelessly elegant, soft and smooth, the candle is framed and set in scene with its impressively large flame. OVAL CANDLE is as iconic as it is functional. Hanging or standing on the table, indoors and outdoors - this lantern enchants every conceivable situation with heart-warming candlelight. And it is always safe and clean thanks to the heat-resistant glass cylinder, drip tray and extinguishing lid.

- ☆ • Suitable for one candle with Ø 50 mm, max. 100 mm long
- 3 holding pins allow the candle to stand securely
- Specially designed candle support by 4 pins, safe stand also for Stearin candles
- Removable wax drip tray underneath the candle ensures safe burning and easy cleaning
- Two different variations: standing base with felt pad or height-adjustable, heat-resistant aramid cord for suspending
- Lid with silicone handle as heat protection and
- To extinguish the candle
- Easy to assemble without tools
- Stainless steel, brushed

🏠 **OVAL CANDLE 35 silver**
10 x 10 x 36 cm, 0.7 kg | gross 12.5 x 12.5 x 43 cm, 1.3 kg
Item No. 00270, EAN 4064251002707

🏠 **OVAL CANDLE 35 black brushed**
10 x 10 x 36 cm, 0.7 kg | gross 12.5 x 12.5 x 43 cm, 1.3 kg
Item no. 00273, EAN 4064251002738

OVAL CANDLE 55 – The elongated version of the lantern with stick candle adds a touch of class to any table and seems to float in space thanks to the included aramid cord. Protected from the wind and safe for atmospheric moments anywhere.

- ☆ • Suitable for one candle with Ø 20–24 mm, max. 250 mm long
- 4 holding pins allow the candle to stand securely
- Specially designed candle support by 4 pins, safe stand also for Stearin candles
- Removable wax drip tray underneath the candle ensures safe burning and easy cleaning
- Two different variations: standing base with felt pad or height-adjustable, heat-resistant aramid cord for suspending
- Lid with silicone handle as heat protection and
- To extinguish the candle
- Easy to assemble without tools
- Stainless steel, brushed

🏠 **OVAL CANDLE 55 silver**
11 x 11 x 55 cm, 0.9 kg | gross 14 x 14 x 64 cm, 1.8 kg
Item No. 00271, EAN 4064251002714

🏠 **OVAL CANDLE 55 black brushed**
11 x 11 x 55 cm, 0.9 kg | gross 14 x 14 x 64 cm, 1.8 kg
Item no. 00274, EAN 4064251002745

OVAL CANDLE WALL MOUNT – To give OVAL CANDLE a permanent place on the wall, install the matching wall mount and let OVAL CANDLE illuminate the room as a floating candlelight.

- ☆ • Simple mounting by cross screw connection, clamping as with a curtain rod
- The OVAL CANDLE is centred in the notch at the front end of the wall mount
- Scope of delivery: Wall mount including screw, dowel and Allen key. No further assembly kit necessary
- Compatible with OVAL CANDLE 35 and 55
- Stainless steel

🏠 **OVAL CANDLE WALL MOUNT silver**
2 x 2 x 8 cm, 0.03 kg
Item No. 00515, EAN 4064251005159

🏠 **OVAL CANDLE WALL MOUNT black**
2 x 2 x 8 cm, 0.03 kg
Item no. 00285, EAN 4064251002851

GRAVITY CANDLE



GRAVITY CANDLE



reddot design award
winner 2018

COLOURS | MATERIALS

LOWER PART zinc die casting
UPPER PART borosilicate glass

 **SILVER**
chrome-plated

 **BLACK**
powder-coated



GRAVITY CANDLE – No matter how you turn GRAVITY CANDLE, with this lantern the candle will always remain perpendicular due to gravity. GRAVITY CANDLE inspires with a gimbal-mounted tea light, making wax splashes from blowing out the candle a thing of the past. Simply turn the GRAVITY CANDLE upside down, and the glass cylinder will slip over the tea light, smothering the flame cleanly and without smoke. In this inverted position, the tea light is also protected from the weather and leaves when not in use.

This gimbal is also extremely useful when lighting. Tilted to the side, the candle can be lit comfortably without the risk of burning. Whether standing on the table, hanging or mounted on a pole: Thanks to the range of accessories, GRAVITY CANDLE offers even more functionalities and enchants favourite places indoors and outdoors with atmospheric candlelight.

- ☆ • Lantern with gimballed candle
- Candle always remains perpendicular due to gravity
- Convenient lighting
- Safe and clean extinguishing of the flame
- Protects against leaves, water and dust when turned upside down
- Secure hold for gastro tea lights
- Optional accessories: hanging system, pole, base
- Lower part: die-cast zinc

🏆 DDC Award 2019
Iconic Award "Innovative Interior" 2019
Focus Open 2018
reddot design award 2018

📏 **GRAVITY CANDLE silver**
Ø 8 cm, 14 cm height, 0.6 kg | gross Ø 10 cm, 15.5 cm height, 0.7 kg
Item No. 080102, EAN 4260447330566

📏 **GRAVITY CANDLE black**
Ø 8 cm, 14 cm height, 0.6 kg | gross Ø 10 cm, 15.5 cm height, 0.7 kg
Item No. 00544, EAN 4064251005449

GRAVITY CANDLE HANGING SYSTEM – Thanks to the optional hanging system, GRAVITY CANDLE floats in space. Assembly is simple and does not require any tools: Pull off the glass cylinder, put on the ring together with the bracket and put the glass cylinder back on. Even in this position, the lantern can simply be turned over to extinguish the candle and is protected from the weather.



- ☆ • Suspension for lantern
- Incl. hanging rope (200 mm) made of black aramid fibre, high heat resistance
- Suspension also possible without rope, e.g. nail
- Stainless steel, brushed

📏 **GRAVITY CANDLE Hanging System**
Ø 8 cm, 17 cm height | gross 18 x 10 x 3 cm, 0.1 kg
Item No. 080201, EAN 4260447330597

GRAVITY CANDLE POLE – With this pole, GRAVITY CANDLE can be mounted anywhere in the garden, but also in a flower pot. GRAVITY CANDLE is simply placed on the basin of the pole and can also be easily turned over in this position to extinguish the candle and is protected from the weather.



- ☆ • Can be extended with base to become a floor light
- 6-part: 4x 30 cm pole Ø 10 mm + basin Ø 7 mm + ground nail (use as ground spike)
- Secure standing position
- Solid stainless steel, brushed

📏 **GRAVITY CANDLE Pole**
123.5 cm height, 0.5 kg | gross 32 x 8 x 4 cm, 0.5 kg
Item No. 080301, EAN 4260447330603

GRAVITY CANDLE BASE – If the GRAVITY CANDLE is to stand freely on the pole, this solid base is mounted.



- ☆ • Enables the GRAVITY CANDLE with pole to be positioned on a firm surface
- Secure standing position
- Solid stainless steel, brushed

📏 **GRAVITY CANDLE Base**
Ø 16.5 cm, 8 mm thickness, 1.4 kg | gross 20 x 20 x 2 cm, 1.4 kg
Item No. 080501, EAN 4260447330610

1 product,
3 versions



Convenient lighting

Safe ending

Close neatly (protected from the weather)



SQUARE CANDLE

COLOURS | MATERIALS

MATERIAL stainless steel



SILVER
brushed



GOLD
brushed



BLACK
powder-coated

SQUARE CANDLE

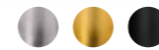

SQUARE CANDLE – Everything begins with a square, which rises from the surface in a flowing movement and forms an amazingly simple candle holder. An exciting interplay of angular austerity and elegant sweep that becomes particularly exciting in the interplay of several SQUARE CANDLES.

- ☆ • Suitable for candles with Ø 20 - 24 mm, max. 250 mm long
- 2 holding pins allow the candle to stand securely
- Stainless steel

📏 **SQUARE CANDLE Candleholder**
17 × 9.5 × 2.5 cm, 0.16 kg | gross 18.2 × 10 × 2.7 cm, 0.25 kg
SQUARE CANDLE silver Item No. 00363, EAN 4064251003636
SQUARE CANDLE gold Item No. 00364, EAN 4064251003643
SQUARE CANDLE black Item No. 00365, EAN 4064251003650

SQUARE CANDLE SET – Thanks to the geometric clarity and your imagination, a wide variety of constellations can be created, making SQUARE CANDLE completely flexible to your needs and occasions and bathing every ambience in soft candlelight.

- ☆ • Set of 4 candle holders
- Suitable for candles with Ø 20–24 mm, max. 250 mm long
- 2 holding pins allow the candle to stand securely
- Stainless steel

📏 **SQUARE CANDLE Set (4pcs)**
4 × 17 × 9.5 × 2.5 cm, 0.16 kg | gross 19 × 11 × 13.3 cm, 0.7 kg
SQUARE CANDLE Set silver Item No. 00367, EAN 4064251003674
SQUARE CANDLE Set gold Item No. 00368, EAN 4064251003681
SQUARE CANDLE Set black Item No. 00369, EAN 4064251003698



CANDLE SHELF P. 69

HENRY METAL

COLOURS | MATERIALS

MATERIAL aluminium



SILVER
brushed



GOLD
brushed



BLACK
brushed

HENRY METAL

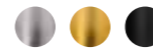

HENRY METAL I – This candleholder sets the stage for the steel beam and lets the structural foundation of industrial architecture shine in a gentle light. Its iconic shape represents boundless possibilities and the bridges built with it connect distances that were thought to be insurmountable. HENRY METAL combines angular hardness with filigree candles and can be combined into an individual sculpture in pairs of multiple candleholders.

- ☆ Suitable for one candle with Ø 20–24 mm, max. 250 mm length
- Precise fitting candle socket, safe stand also for stearin candles
- Arrangement with another HENRY METAL I or HENRY METAL II candleholder possible
- Felt pad for optimal positioning when arranging and to avoid scratches on sensitive surfaces
- High-quality aluminium with anodised finish

📏 **HENRY METAL I**
0.48 x 0.48 x 13.5 cm, 0.23 kg | gross 16 x 7 x 5.5 cm, 0.26 kg
HENRY METAL I silver Item No. 00657, EAN 4064251006576
HENRY METAL I gold Item No. 00658, EAN 4064251006583
HENRY METAL I black Item No. 00659, EAN 4064251006590



HENRY METAL II – Likewise, the elongated version of the candleholder with room for two stick candles sets highlights on any table. In combination with another HENRY METAL I or HENRY METAL II, various compositions can be created. A homage to the architecture in every home.

- ☆ Suitable for up to two candles with Ø 20–24 mm, max. 250 mm length
- Precise fitting candle socket, safe stand also for stearin candles
- Arrangement with another HENRY METAL I or HENRY METAL II candleholder possible
- Felt pad for optimal positioning when arranging and to avoid scratches on sensitive surfaces
- High-quality aluminium with anodised finish

📏 **HENRY METAL II**
30 x 5 x 5 cm, 0.5 kg | gross 32 x 5.5 x 7 cm, 0.6 kg
HENRY METAL II silver Item No. 00660, EAN 4064251006613
HENRY METAL II gold Item No. 00661, EAN 4064251006620
HENRY METAL II black Item No. 00662, EAN 4064251006637





BOWL

BOWL 57 | BOWL 70



MATERIALS

HEMISPHERE & INNER ASH TRAY Steel, enamelled
STANDS Stainless steel, solid



BOWL 57 | 70 – With the BOWL 57 | 70, the fire experience reaches a new dimension. Thanks to the optimised hemisphere and ash tray with perfected air supply, the fire burns even cleaner and more pleasantly.

Its simple elegance and fascinating multifunctionality continue to ensure unforgettable barbecue evenings and standing parties by the open fire. Now available in two sizes, the BOWL 57 and BOWL 70 together with the revised range of accessories are a real highlight for BOWL professionals as well as BOWL novices!

- ☆ **Fire bowl with expandable grill function**
- ☆ **Tilting hemisphere: optimal wind protection & heat orientation**
- ☆ **Low-smoke fire thanks to improved air supply**
- ☆ **Easy cleaning thanks to removable ash pan**
- ☆ **Secure stand on solid star stand or screw-on tripod made of stainless steel**
- ☆ **Quick to assemble & disassemble without tools**
- ☆ **Verified according to barbecue standard EN1860**
- ☆ **Hemisphere: steel, enamelled**
- ☆ **Internal ash tray: steel, enamelled**
- ☆ **BOWL 57 | 70 Star Stand: stainless steel, solid**
- ☆ **BOWL 57 | 70 Tripod: stainless steel**
- ☆ **Optional grill accessories: BOWL 57 | 70 Grid, BOWL 57 | 70 Plancha, BOWL 57 | 70 Sear Grate, BOWL 57 | 70 Warming Ring**

- 🏆 Red Dot Design Award 2024
- 🏆 iF Design Award 2024
- 🏆 German Design Award 2021
- 🏆 Iconic Award "Innovative Interior" 2020 best of best
- 🏆 Focus Open Design Award 2019
- 🏆 archiproducts design award 2019

📏 BOWL 57 Fire Bowl with Star Stand	📏 BOWL 57 Fire Bowl with Tripod
Grill height: 41 cm	Grill height: 75 cm
Packed dimensions: 59.5 x 59.5 x 36 cm	Packed dimensions: 59.5 x 59.5 x 32 cm
Fire bowl: Ø 57 cm, 25 cm high	Fire bowl: Ø 57 cm, 25 cm high
Weight: 6.8 kg	Weight: 7.8 kg
Star foot height: 22.2 cm	Tripod height unfolded: 58 cm
Weight: 1.1 kg	Weight: 2.2 kg
Item No. 00249, EAN 4064251002493	Item No. 00250, EAN 4064251002509

📏 BOWL 70 Fire Bowl with Star Stand	📏 BOWL 70 Fire Bowl with Tripod
Grill height: 48 cm	Grill height: 85 cm
Packed dimensions: 72.5 x 72.5 x 40.5 cm	Packed dimensions: 73 x 73 x 37 cm
Fire bowl: Ø 70 cm, 31.5 cm high	Fire bowl: Ø 70 cm, 31.5 cm high
Weight: 12.9 kg	Weight: 14.4 kg
Star foot height: 24 cm	Tripod height unfolded: 77 cm
Weight: 1.96 kg	Weight: 2.7 kg
Item No. 00257, EAN 4064251002578	Item No. 00258, EAN 4064251002585



BOWL 57 | 70 PLANCHA BBQ SET LOW & HIGH

With the BOWL 57 | 70 Plancha BBQ Set, nothing stands in the way of unforgettable barbecue evenings and lounge parties by the open fire. The black steel hemisphere sits securely on the tripod and provides warmth for numerous friends in its horizontal orientation. The two included planchas transform the fire bowl into an extra-large plancha grill in no time at all, with plenty of room for meat, fish or veggies.

- ☆ **All features of the BOWL 57 | 70 Fire bowl**
- ☆ **Includes 2 enamelled BOWL 57 | 70 Planchas with good heat retention and non-stick coating**
- ☆ **Optionally as a barbecue set with BOWL 57 | 70 Star Stand or BOWL 57 | 70 Tripod**
- ☆ **Optional grill accessories: BOWL 57 | 70 Grid, BOWL 57 | 70 Sear Grate, 57 | 70 Warming Ring**

📏 BOWL 57 Plancha BBQ Set low	📏 BOWL 57 Plancha BBQ Set high
Fire bowl: Ø 57 cm, 25 cm height	Fire bowl: Ø 57 cm, 25 cm height
BOWL 57 on star stand: 41.5 cm height, 6.8 kg gross 62x62x38.5cm, 15.9kg	BOWL 57 on tripod: 74 cm height, 7.8 kg gross 62x62x38.5cm, 16.9kg
Item No. 00608, EAN 4064251006088	Item No. 00607, EAN 4064251006071

BOWL 57 Plancha 57x28,5x1,9 cm, 4,6 kg, Packed dimensions: 60.5 x 31 x 4 cm, 5,2 kg

📏 BOWL 70 Plancha BBQ Set low	📏 BOWL 70 Plancha BBQ Set high
Fire bowl: Ø 70 cm, 31.5 cm high	Fire bowl: Ø 70 cm, 31.5 cm high
BOWL 70 on star stand: 48 cm height, 12.9 kg gross 73x73x40.5cm, 26,3 kg	BOWL 70 on tripod: 85 cm height, 14.4 kg gross 73x73x40.5cm, 27.8 kg
Item No. 00647, EAN 4064251006477	Item No. 00646, EAN 4064251006460

BOWL 70 Plancha 70x35x2 cm, 6,7kg, Packed dimensions: 73.5 x 37.0 x 4 cm, 7kg



BOWL 57 | 70 FIRE SET FLEX –

The BOWL 57 | 70 Fire Set is the perfect accessory that flexes to suit the mood. Enthusiastically multifunctional, the fire bowl with its included stable star stand and screw-on tripod ensures maximum flexibility for cosy fire evenings on the terrace or in the garden. In just a few simple steps and without tools, it can be changed from a casual standing party to a lounge atmosphere.

- ☆ **All features of the BOWL 57 | 70 Fire bowl**
- ☆ **Includes BOWL 57 | 70 Star Stand and BOWL 57 | 70 Tripod for use as a raised and ground-level fire bowl**
- ☆ **Optional grill accessories: BOWL 57 | 70 Grid, BOWL 57 | 70 Plancha, BOWL 57 | 70 Sear Grate, 57 | 70 Warming Ring**

📏 BOWL 57 Fire Set flex	📏 BOWL 70 Fire Set flex
fire bowl: Ø 57 cm, 25 cm height, BOWL 57 on star stand: 41.5 cm height, 6.8 kg gross 62x62x38.5cm, 11.2 kg	fire bowl: Ø 70 cm, 31.5 cm height, BOWL 70 on star stand: 48 cm height, 12.9 kg gross 73x73x40.5 cm, 15.6 kg
Item No. 00618, EAN 4064251006187	Item No. 00645, EAN 4064251006453

📏 BOWL 57 Tripod	📏 BOWL 70 Tripod
Packed dimensions: 47 x 8.6 x 11 cm	Packed dimensions: 54 x 11 x 12.5 cm
Weight: 2.2 kg	Weight: 2.7 kg

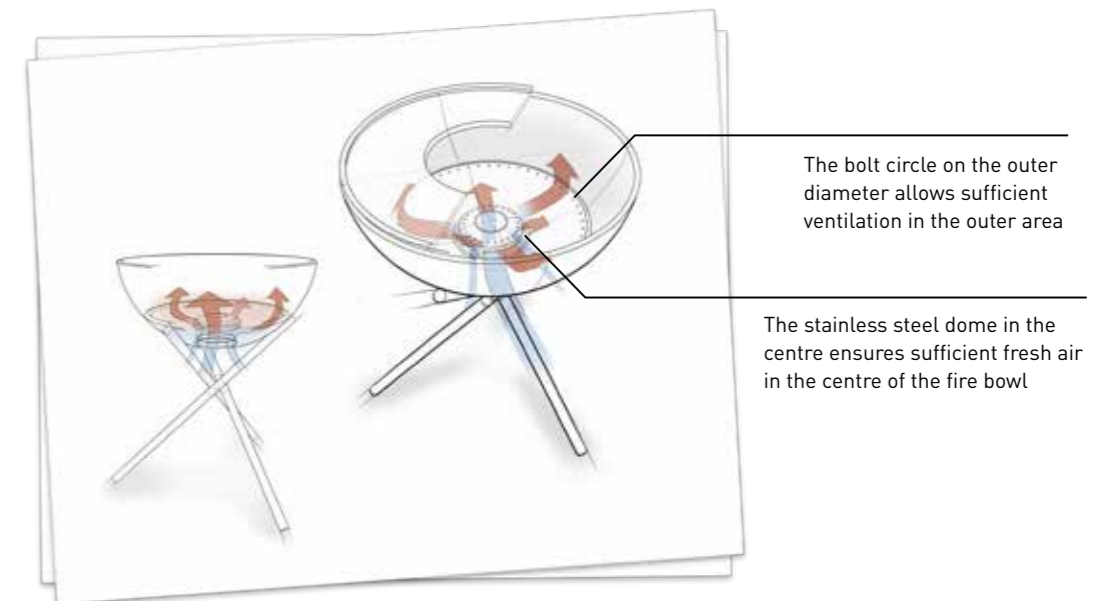
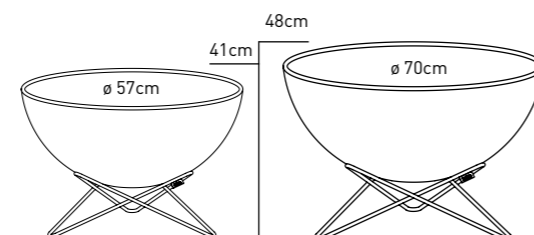
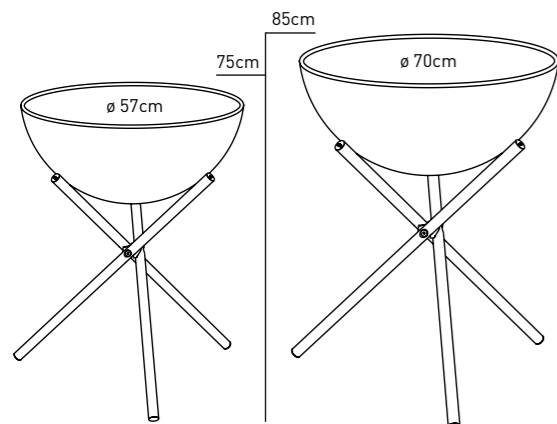

The bolt circle on the outer diameter allows sufficient ventilation in the outer area

The stainless steel dome in the centre ensures sufficient fresh air in the centre of the fire bowl

THE FIRE BOWL THAT CAN DO EVERYTHING



High and low position



Tilted fire bowl: optimal wind protection

STANDS BOWL

SUITABLE FOR ALL BOWL MODELS



BOWL 57 | 70 STAR STAND – The elegant star stand transforms the BOWL 57 | 70 into a fire bowl with a lounge atmosphere that makes no one want to get up any time soon. Whether horizontal with optional plancha and grid or tilted: With the star stand, the heat is directed exactly where it is needed most.

BOWL 57 | 70 TRIPOD – In no time at all, the tripod raises the BOWL, BOWL 57 and BOWL 70 to a comfortable waist height and thus an optimal grilling position (grid and plancha additionally available). The screw-on BOWL 57 | 70 Tripod impresses with an even more slender look with the usual stability, which offers every BOWL a secure hold in a neutral or even tilted position and lets you enjoy the fire without worrying.

- ☆ • Secure stance on one-piece, solid star stand
- Quick to assemble & disassemble without tools
- Attached hemisphere can be positioned neutral or inclined
- Stainless steel, solid

BOWL 57 Star Stand	BOWL 70 Star Stand
Star stand height: 22.2 cm	Star stand height: 24 cm
Packed dimensions: 48 x 43 x 24 cm	Packed dimensions: 57 x 51.5 x 26 cm
Weight: 1.10 kg	Weight: 1.96 kg
Item No. 00343, EAN 4064251003438	Item No. 00259, EAN 4064251002592

- ☆ • Secure standing position on solid tripod
- Slender look
- Waterproof screw-on
- Quick to assemble & disassemble without tools
- Attached hemisphere can be positioned neutral or inclined
- Stainless steel, solid

BOWL 57 Tripod	BOWL 70 Tripod
Tripod height extended: 58 cm	Tripod height extended: 77 cm
Grill height (with BOWL 57): 73.6 cm	Grill height (with BOWL 70): 85 cm
Packed dimensions: 47 x 8.6 x 11 cm	Packed dimensions: 54 x 11 x 12.5 cm
Weight: 2.2 kg	Weight: 2.7 kg
Item No. 00342, EAN 4064251003421	Item No. 00260, EAN 4064251002608

A BARBECUE EXPERIENCE TO REMEMBER



Plancha

Grill Grid

Sear Grate

Warming Ring

FIRE KITCHEN OUTDOOR KITCHEN P. 36



ACCESSORIES BOWL

SUITABLE FOR ALL BOWL MODELS

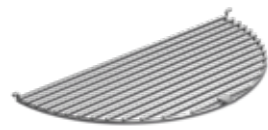

BOWL 57 | 70 GRID – High rust resistance thanks to polished stainless steel and supported by three contact points, the new grid guarantees lifelong fire enjoyment. To take the culinary flight of fancy to the extreme, the grid can easily be combined with a plancha or a second grid half.

- ☆ **One-piece grid made of polished stainless steel**
- **Ø 6 mm bars**
- **Secure support via three support points**
- **Additional support strut for the BOWL 70**
- **Can be combined with BOWL 57 | 70 Plancha or another BOWL 57 | 70 Grid**

BOWL 57 Grid	BOWL 70 Grid
Dimensions: Ø 57 cm, rods Ø 6 mm	Dimensions: Ø 70 cm, rods Ø 6 mm
Packed dimensions: 59.5 x 32 x 4 cm	Packed dimensions: 72 x 37 x 4.5 cm
Weight: 1.43 kg (one half)	Weight: 2.1 kg (one half)
Item No. 00339, EAN 4064251003391	Item No. 00264, EAN 4064251002644



BOWL 57 | 70 LID – Worries about flying sparks and ash clouds are a thing of the past thanks to the BOWL 57 | 70 lid. The glowing ashes remain safely sealed in the BOWL and even external weather conditions roll off the BOWL thanks to well thought-out details. Without slipping or wobbling, the lid sits stably on each BOWL version and can also be used as a storage surface.

- ☆ **Cover after use to avoid flying sparks**
- **Weatherproof**
- **Strong, non-slip and wobble-resistant, can also be used as a storage surface**
- **Domed lid prevents water accumulation**
- **Side drip edge that prevents water from entering the BOWL**
- **Stainless steel, brushed**

BOWL 57 Lid	BOWL 70 Lid
Dimensions: Ø 57 cm, height 1.8 cm	Dimensions: Ø 70 cm, height 1.8 cm
Packed dimensions: 60.0 x 60.0 x 3.5 cm	Packed dimensions: 72.0 x 72.0 x 3.5 cm
Weight: 3.1 kg	Weight: 4.8 kg
Item No. 00478, EAN 4064251004787	Item No. 00479, EAN 4064251004794



BOWL 57 | 70 PLANCHA – Cooking on a hot surface heated by fire - a millennia-old tradition, worldwide, in the most diverse cultures. In Spain it became the plancha, the Japanese call it teppanyaki. The variety of dishes that can be cooked or grilled on a hot plate is countless. Thanks to the small outer rim, fats and oils also stay exactly where they belong - on the plancha.

- ☆ **Half-ring enamelled cast iron, optimum heat retention**
- **Non-stick coating for low-fat frying & cooking**
- **With small outer rim so that fat or grilled food cannot fall off**
- **Secure support via three contact points**
- **Fire ring is created from two planchas**
- **Can be combined with BOWL 57 | 70 Grid or another BOWL 57 | 70 Plancha**

BOWL 57 Plancha	BOWL 70 Plancha
57x28,5x1,9 cm, 4,6 kg, Packed dimensions: 60.5 x 31 x 4 cm, 5.2 kg	70x35x2 cm, 6,7kg, Packed dimensions: 73.5 x 37.0 x 4 cm, 7kg
Item No. 00256, EAN 4064251002561	Item No. 00263, EAN 4064251002639



BOWL 57 | 70 BOARD – Not only as a fire bowl, but also as a storage surface, the BOWL cuts a fine figure. The support board fits securely, stably and without wobbling on the fire bowl. Whether mounted at standing height or close to the floor, thanks to the support board everything remains within reach.

- ☆ **Non-slip and wobble-proof support thanks to precisely fitting indentation**
- **Turns BOWL into a side table when not in use**
- **Bamboo solid wood with UV-resistant coating**

BOWL 57 Board	BOWL 70 Board
Dimensions: Ø 57 cm, height 1.8 cm	Dimensions: Ø 70 cm, height 1.8 cm
Packed dimensions: 60 x 60 x 3.5 cm	Packed dimensions: 72 x 72 x 3.5 cm
Weight: 4.2 kg	Weight: 6 kg
Item No. 00569, EAN 4064251005692	Item No. 00570, EAN 4064251005708



BOWL 57 | 70 SEAR GRATE – The BOWL 57 | 70 Sear Grate is more than a cast iron grate. Together with the support ring and the handle, it offers a range of options for grilling and cooking over open flames that leaves even barbecue professionals in raptures. The cast iron grate extends the grilling surface and is ideal for searing when placed directly in the middle of the plancha ring. Positioned on the support ring, the flame proximity and thus the temperature can be regulated over various levels. The cast iron grate can be inserted and removed in no time with the included handle, which also creates space for a wok pan. Placed into the support ring over four different levels, the pan is positioned directly above the flames and adds a special touch to any dish.

- ☆ **Solid cast iron grate, optimal heat retention**
- **Can be positioned on the height-adjustable rack or placed directly on the opening of the plancha ring**
- **Also ideal for using a wok or iron pan on the rack ring: safe standing thanks to the built-in three-point support**
- **Solid lifting tool made of cast iron for inserting / removing the cast iron grate**
- **Space-saving storage when dismantled**
- **Cast iron grate: solid cast iron with high-quality enamel coating**
- **Rack with ring: support ring made of solid cast iron, the rods made of high-quality stainless steel**
- **Suitable for the BOWL and BOWL 57 | 70 Plancha ring (consisting of 2 plancha halves)**
- **Optional extension with BOWL 57 | 70 Warming Ring**

BOWL 57 Sear Grate	BOWL 70 Sear Grate
Packed dimensions: 29x 29 x 6 cm	Packed dimensions: 34 x 34 x 6 cm
Weight: 3,2kg	Weight: 4,5kg
Item No. 00611 EAN 4064251006118	Item No. 00615 EAN 4064251006156



BOWL 57 | 70 COVER – To keep the BOWL protected even when not in use, the BOWL cover keeps dirt and moisture out.

- ☆ **Custom-fit protective cover for all BOWL variants**
- **Hard-wearing polyester-nylon blend fabric**
- **Water-repellent**

BOWL 57 Cover	BOWL 70 Cover
Dimensions: Ø 57 cm	Dimensions: Ø 70 cm
Packed dimensions: 26 x 26 x 3 cm	Packed dimensions: 26 x 33 x 3 cm
Weight: 0.22 kg	Weight: 0.26 kg
Item No. 00001, EAN 4064251000017	Item No. 00265, EAN 4064251002653



BOWL 57 | 70 WARMING RING – With the BOWL 57 | 70 Warming Ring, the barbecue collection gains a boost that catapults your grilling and cooking options exponentially upwards. Simply placed on the support ring of the Sear Grate, the Warming Ring offers 60% more space over the flames to keep ready-to-eat delicacies at an optimal temperature or to gently prepare delicate grilled food such as bread or vegetables. Surrounding the cast iron grate, as a tray around an iron pan or solo as a second grilling level above the plancha ring - the Warming Ring offers countless facets that are waiting to be discovered.

- ☆ **Warming Ring enamelled cast iron, optimum heat retention**
- **Non-stick coating for low-fat grilling & cooking**
- **Lowered with small outer rim so that grease or grilled food cannot fall off**
- **Can be placed on the rack of the BOWL 57 | 70 Sear Grate without assembly**

BOWL 57 Warming Ring	BOWL 70 Warming Ring
Packed dimensions: 48 x 48 x 3 cm	Packed dimensions: 57,5 x 57,5 x 3 cm
Weight: 6,1 kg	Weight: 8,2 kg
Item No. 00613 EAN 4064251006132	Item No. 00617 EAN 4064251006170

BBQ TOOLS P. 64 – 67

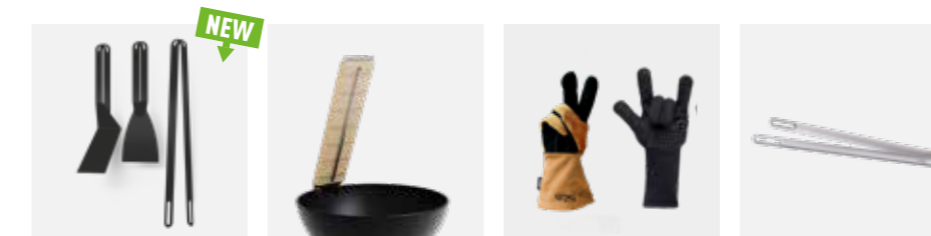

BBQ Tools

Flame Grilled Salmon Board

Fire Gloves

Fire Tongs

FIRE KITCHEN

BOWL | BOWL 57 | BOWL 70



Outdoor grilling and cooking fun

Suitable for all BOWLS

Storage for tools, spices, toppings, etc.

Wheels for mobility

Perfect working height

Worktop made from beech wood

Stainless steel ingredient container

Height-adjustable feet

One product, many possibilities





FIRE KITCHEN – The mobile outdoor kitchen is the solution for anyone who has a passion for outdoor cooking and barbecuing. The robust and durable kitchen consists of a welded steel frame with integrated BOWL, BOWL 57 or BOWL 70 (all accessories) and offers storage and work surfaces on three different levels. Specially designed for outdoor use, it makes no compromises with its high-quality, weather-resistant materials and can be assembled modularly with the various inserts to create a completely individual culinary journey.

- ☆ • Sturdy welded frame with 4 adjustable feet for easy positioning of the FIRE KITCHEN
- Grilling and cooking on three levels with wooden worktop and shelves
- Middle shelf converts FIRE KITCHEN into a counter
- Frame: Stainless steel, solid
- Wooden worktop: solid beech wood
- Centre shelf: brushed stainless steel
- Bottom shelf: steel, powder-coated
- Scope of delivery: FIRE KITCHEN, 2 shelves, 1 wooden worktop
- Optional accessories: BOWL 57 | 70 Plancha BBQ Set, FIRE KITCHEN Stainless Steel Container Set, FIRE KITCHEN Wheel Set

🏆 Red Dot Design Award 2024
iF Design Award 2024
archiproducts design award 2023

📦 **FIRE KITCHEN Outdoor Kitchen**
Dimensions: 118 x 55 x 81 cm, Weight: 37 kg, Height Worktop: 82 cm
Packed dimensions: 120 x 57 x 85 cm, Weight: 39 kg
Item No. 00748, EAN 4064251007481

- ☆ • All features of the FIRE KITCHEN
- All features of the BOWL 57 | 70 Plancha BBQ Set low
- Optionally with BOWL 57 or BOWL 70 Plancha BBQ Set low
- Scope of delivery: FIRE KITCHEN, 2 shelves, 1 wooden worktop, BOWL 57 | 70 Plancha BBQ Set low
- Optional accessories: FIRE KITCHEN Stainless Steel Container Set, FIRE KITCHEN Wheel Set

🏆 Red Dot Design Award 2024
iF Design Award 2024
archiproducts design award 2023

<p>📦 FIRE KITCHEN with BOWL 57 Plancha BBQ Set low Dimensions: 118 x 55 x 81 cm Weight: 53,5 kg Grill height: 91 cm Bowl 57 on star stand: 41.5 cm Packed dimensions: 120 x 57 x 129 cm, 60.5 kg Item No. 00739, EAN 4064251007399</p>	<p>FIRE KITCHEN with BOWL 70 Plancha BBQ Set low Dimensions: 118 x 55 x 81 cm Weight: 64 kg Grill height: 101 cm Bowl 70 on star stand: 48 cm Packed dimensions: 120 x 57 x 134 cm, 70.8 kg Item No. 00740, EAN 4064251007405</p>
---	--

- ☆ • 5 stainless steel containers according to gastronomic standard
- 3x GN container 2/4, 65mm deep, 1x GN container 2/4, 100mm deep, 1x GN container 1/1, 100mm deep
- For use on the top and middle level of the FIRE KITCHEN
- Stainless steel

📦 **FIRE KITCHEN Stainless Steel Container Set (5 pcs)**
Packed dimensions: 53 x 32 x 18 cm, Weight: 6 kg
Item No. 00764, EAN 4064251007641

- ☆ • Tool Box for hanging on the FIRE KITCHEN
Can be attached without tools
Slots for rainwater drainage
55 cm x 10 cm x 10 cm
Stainless steel

📦 **FIRE KITCHEN Tool Box**
Packed dimensions: 56,5 x 15 x 12 cm, Weight: 1.7 kg
Item No. 00830, EAN 4064251008303



FIRE KITCHEN WHEEL SET – Whether on the patio or in the garden, the wheels with engraved rims make your FIRE KITCHEN portable and easy to roll.

- ☆ • 2 large wheels (Ø 17.5 cm) with engraved rims

📦 **FIRE KITCHEN Wheel Set (2 pcs)**
Packed dimensions: 38 x 18 x 7 cm, Weight: 2.3 kg
Item No. 00747, EAN 4064251007474



FIRE KITCHEN COVER 57 | 70 – The water-repellent cover protects against wind and weather. It is simply pulled over the FIRE KITCHEN and secured to the FIRE KITCHEN by means of hook-and-loop fasteners. Side ventilation slits allow plenty of fresh air under the cover to make your next barbecue a pleasure.

- ☆ • Custom-fit protective cover for the FIRE KITCHEN with BOWL 57 | 70
- 4-fold hook and loop fastener for secure attachment
- Side ventilation slits for good air circulation
- Polyester with PVC coating, water-repellent

📦 **FIRE KITCHEN Cover 57**
Packed dimensions: 51 x 36 x 5 cm, Weight: 1.9 kg
Item No. 00826, EAN 4064251008266

FIRE KITCHEN Cover 70
Packed dimensions: 51 x 36 x 5 cm, Weight: 2.2 kg
Item No. 00827, EAN 4064251008273



FIRE KITCHEN WITH BOWL 57 | 70 PLANCHA BBQ SET – The Outdoor Kitchen with integrated BOWL 57 or BOWL 70 Plancha BBQ Set is the perfect choice for anyone who wants to enjoy grilling and cooking outdoors. It positions the BOWL 57 or BOWL 70 at the perfect working height and offers plenty of space on several levels for preparing delicacies. After the barbecue, the BOWL 57 | 70 can still be enjoyed as a fire bowl at ground level on the star stand provided.

<p>📦 FIRE KITCHEN with BOWL 57 Plancha BBQ Set low Dimensions: 118 x 55 x 81 cm Weight: 53,5 kg Grill height: 91 cm Bowl 57 on star stand: 41.5 cm Packed dimensions: 120 x 57 x 129 cm, 60.5 kg Item No. 00739, EAN 4064251007399</p>	<p>FIRE KITCHEN with BOWL 70 Plancha BBQ Set low Dimensions: 118 x 55 x 81 cm Weight: 64 kg Grill height: 101 cm Bowl 70 on star stand: 48 cm Packed dimensions: 120 x 57 x 134 cm, 70.8 kg Item No. 00740, EAN 4064251007405</p>
---	--



FIRE KITCHEN STAINLESS STEEL CONTAINER SET – The five-piece set provides ample space for all the ingredients you need to prepare your menu over the fire. You can place them on either the middle or top level and even cover them with the worktop.



FIRE KITCHEN TOOL BOX – Even more storage space for spices, BBQ tools, toppings or other ingredients for the best dishes over the flames. Simply hook the Tool Box into the FIRE KITCHEN frame and place it where you need it most. At the end of the evening, you can take it back to the kitchen or leave it hanging on the FIRE KITCHEN, where the practical slits allow rainwater to drain away.

NEW



TOOLS SHELF P. 69



MOON

MOON 45



MATERIALS

HEMISPHERE & INNER ASH TRAY

Enamelled steel and brushed stainless steel or stainless steel PVD-coated

STANDS Enamelled steel and brushed stainless steel

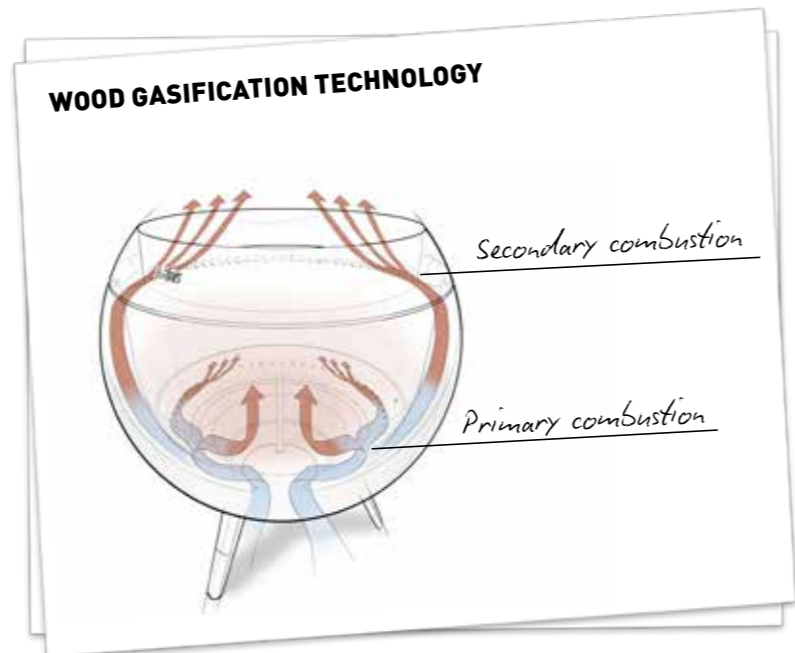

MOON 45 – The unrivalled MOON with revolutionary burner technology based on the principle of wood gasification, makes flames and hearts beat faster. The design of the elegant black sphere appears weightless and adds a fascinating lightness to any occasion.

Its double wall, consisting of an inner and outer bowl, allows for a split air supply. This groundbreaking design not only heats the fuel (either wood or pellets) in the heart of the fire basket, but also allows for a second, fascinating combustion below the opening. The air is heated in the double wall, rises to the top and burns the smallest particles of wood that can no longer escape as smoke.

This effect not only creates an enchanting and unique interplay of flames, but also increases the heat output and drastically reduces the amount of smoke emitted, making it the most environmentally friendly fire basket available.

The MOON is available with a choice of stands to suit any garden party. A masterpiece in the world of fire.

- ☆ • Ground-level fire basket with wood gasification technology
- Fascinating flame effect and low-smoke fire thanks to two-stage combustion process
- Can be heated with logs or pellets
- Combustion with little residue when using wood
- Safe stand on low cast iron stand or high stainless steel stand
- Quick assembly & disassembly without tools
- Easy to clean due to removable ash tray
- Easy to transport
- Inner bowl: silver stainless steel, outer bowl: enamelled steel
- Ash tray: Enamelled steel and silver stainless steel
- Extension nozzle: Brushed stainless steel. Surface acquires a unique colour gradient with use.
- Low stand: enamelled cast iron
- High stand: Brushed stainless steel
- Scope of delivery: MOON 45 outer and inner bowl, fire grid, ash tray, extension nozzle, low or high stand

MOON 45 Fire basket with low stand	MOON 45 Fire basket with high stand
Fire Bowl: Ø 45 cm	Fire Bowl: Ø 45 cm
Height fire bowl on low foot: 49 cm	Height fire bowl on high foot: 75 cm
Weight: 10.21 kg	Weight: 10.96 kg
Packed dimensions: 51 x 51 x 43 cm	Packed dimensions: 51 x 51 x 43 cm
Weight: 17.75 kg	Weight: 18.25 kg
Item No. 00716, EAN 4064251007160	Item No. 00717, EAN 4064251007177

- 🏆 German Design Award 2025
- 🏆 Focus Open Design Award 2024
- 🏆 archiproducts award winner 2024

Low-smoke fire

Can be fired with both wood logs and pellets

Increased heat output

High and low stand



ACCESSORIES MOON



MOON 45 LOW STAND – Always connected to the ground, MOON sits securely on the low cast stand and creates a cosy lounge atmosphere. The short legs of the cast stand fit elegantly into the overall appearance of MOON and ensure that no one wants to go home any time soon.

- ☆ Easy conversion to ground level fire bowl
- ☆ Stands securely on solid cast iron stand
- ☆ Quick assembly & disassembly without tools
- ☆ Solid cast iron with matte black enamel finish

MOON 45 Low Stand
 Product dimensions: 28 x 32 x 14 cm, Weight: 1.7 kg
 Packed dimensions: 42 x 42 x 21 cm, Weight: 3 kg
 Item No. 00718, EAN 4064251007184



MOON 45 HIGH STAND – For the perfect atmosphere at your next garden party. The three brushed stainless steel legs create a sleek look. And when not in use, the stand can be unscrewed and stored to save space.

- ☆ Easy conversion to raised fire bowl
- ☆ Secure stand
- ☆ Easy to screw feet to supporting ring
- ☆ Support ring: black enamelled cast iron
- ☆ Legs: brushed stainless steel

MOON 45 High Stand
 Product dimensions: 48 x 55 x 40 cm, Weight: 2.3 kg
 Packing dimensions: 58 x 29 x 12 cm, Weight: 3.7 kg
 Item no. 00719, EAN 4064251007191



MOON 45 PLANCHA – Fuelled by wood or pellets, the MOON fire basket produces precise heat for creative grilling and cooking. The plancha ring offers plenty of space for all kinds of delicacies, which can be prepared with little fat thanks to the optimum heat retention and non-stick coating of the cast iron plate, expanding your culinary options above the flames.

- ☆ Continuous plancha ring: 53cm diameter and 16cm centre opening
- ☆ Can be used as a grill insert for wood or pellet fires
- ☆ Stable thanks to integrated three-point support
- ☆ Optimum heat retention and non-stick coating
- ☆ Lowered with outer edge to prevent fat or food from falling off
- ☆ Enamelled cast iron

MOON 45 Plancha
 Product dimensions: 53 x 53 x 9 cm, Weight: 12 kg
 Packing dimensions: 58 x 58 x 13 cm, Weight: 15 kg
 Item No. 00861, EAN 4064251008617



MOON 45 ASH TRAY EXTENSION – The practical extension prolongs the smokeless fire enjoyment indefinitely. Simply screw the ring onto the ash tray, and it safely captures all glowing pellets. With the included lifter, the ash tray can be effortlessly removed from the MOON fire basket, emptied, and refilled with pellets – ensuring clean, easy handling and a consistently relaxing fire experience.

- ☆ Extends the smokeless fire with pellets in the MOON Fire Basket
- ☆ Enables easy removal, emptying, and refilling of the MOON ash tray
- ☆ Sturdy stainless steel ring for attachment to the ash tray with screws
- ☆ Scope of delivery: MOON Extension Ring, MOON Lifter

MOON 45 Ash Tray Extension
 Product dimensions: Ring Ø 37.5 cm, height 8.5 cm, weight: 0.7 kg
 Lifter dimensions: 31.5 x 10 x 2 cm, weight: 0.1 kg
 Packaging dimensions: 42.5 x 42.5 x 10 cm, weight: 1.2 kg
 Item no. 00832, EAN 4064251008327



MOON 45 ASH TRAY WITH EXTENSION – The complete set of ash tray, extension ring, and lifter ensures uninterrupted, smokeless fire enjoyment. The ash tray can be easily removed from the MOON fire basket using the included lifter, emptied, and refilled, or replaced with another ash tray with extension if needed. For clean handling and a relaxing, uninterrupted fire experience.

- ☆ Complete set of ash tray, extension ring, and lifter
- ☆ Extends the smokeless fire with pellets in the MOON fire basket
- ☆ For easy swapping of the MOON ash tray in the MOON Fire Basket
- ☆ Enables easy removal, emptying, refilling, or exchange of the MOON ash tray
- ☆ Sturdy stainless steel ring for attachment to the ash tray with screws
- ☆ Included in delivery: MOON Extension Ring, MOON Ash Tray, MOON Lifter

MOON 45 Ash Tray with Extension
 Ring with ash tray mounted Ø 37.5 cm, height 17.5 cm, weight: 3.8 kg
 Lifter dimensions: 31.5 x 10 x 2 cm, weight: 0.1 kg
 Item no. 00973, EAN 4064251009737



MOON 45 SPARK GUARD – Specially designed to prevent flying sparks, this highly effective guard creates a safe environment for undisturbed fire enjoyment. Simply slipped over the MOON's opening, the spark guard provides safety and a clear view of the fascinating dance of flames.

- ☆ Cover mesh during fire to reduce flying sparks
- ☆ Easy to fit and remove
- ☆ Fits under the lid and cover
- ☆ Stainless steel ring with stainless steel mesh

MOON 45 Spark Guard
 Product dimensions: 34 x 34 x 7 cm, Weight: 0.4 kg
 Packing dimensions: 35 x 35 x 8 cm, Weight: 0.6 kg
 Item No. 00808, EAN 4064251008082



MOON 45 LID – Worries about flying sparks and clouds of ash are a thing of the past with the MOON lid. Glowing ash is safely contained within MOON, while clever details ensure that wind and weather are kept out.

- ☆ Cover after use to prevent flying ash and sparks
- ☆ Weatherproof, sturdy and non-slip domed lid prevents water from collecting
- ☆ Complete coverage of the MOON prevents water ingress
- ☆ Can be placed over the spark guard
- ☆ Fits under the cover
- ☆ Brushed stainless steel

MOON 45 Lid
 Product dimensions: 43 x 43 x 15 cm, Weight: 1.2 kg
 Packing dimensions: 43.5 x 43.5 x 17 cm, Weight: 1.9 kg
 Item No. 00807, EAN 4064251008075



MOON 45 COVER – The protective cover for MOON is easy to put on and secure. The practical drawstring with cord stopper at the bottom of the cover ensures a firm and secure hold in all weathers. The material is water-repellent and protects against dirt and moisture.

- ☆ Perfectly fitting protective cover
- ☆ Easy to fit
- ☆ Spark guard and lid can remain under the cover
- ☆ Drawstring with cord stopper at bottom
- ☆ Water-repellent and durable polyester/nylon blend fabric

MOON 45 Cover
 Product dimensions: 45 x 45 x 27 cm, Weight: 0.28 kg
 Packing dimensions: 33 x 26 x 4 cm, Weight: 0.4 kg
 Item No. 00815, EAN 4064251008150

CUBE

BRONZE
DGC
GUTE
GESTALTUNG
2019

ICD 2
RIG 2
RMA 2
RUS 2
INNOVATIVE
INTERIOR
best of best

dezeen
awards
2019 longlisted

GERMAN
DESIGN
AWARD
WINNER
2017



Forma Open 2017
Baden-Württemberg
International Design Award

reddot design award
winner 2016

DESIGN PLUS
Winner 2016



CUBE

MATERIAL



CUBE BLACK
100% stainless
steel, powder-
coated



**CUBE CORTEN
STEEL**
100% Corten steel

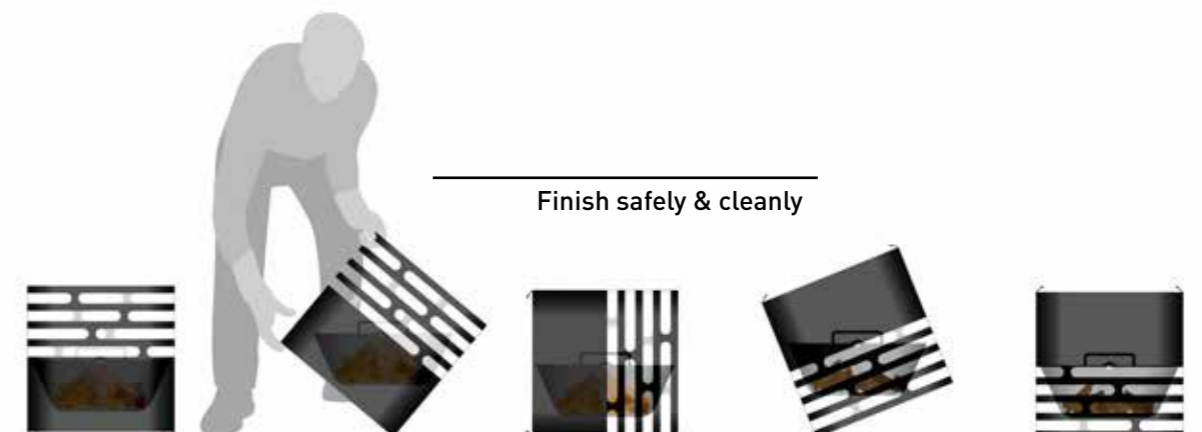



CUBE BLACK – Enjoy the warmth of the fire without any worries. Thanks to its sophisticated design, CUBE encloses the fire remains, reduces flying sparks and safely stores the ashes. The outer fire basket is simply turned over while the inside ash tray always remains in balance due to gravity. No ashes are dropped and the fire is choked.

Without worrying about the fire going out, the time by the fire can be enjoyed even more. Choose to grill on the grid or plancha, both easily adjusted in height and heat exposure. If no fire is burning inside the CUBE, it can be used as a stool, a bench or a side table – a multi-purpose piece of outdoor furniture which surprises, enthuses and gives lasting joy due to its high quality materiality.

- ☆ • Fire basket with optional extension to grill and stool
- Rotatable ash tray: fire basket can be turned over during burning, the fire goes out
- Stainless steel, powder-coated
- Optional accessories: CUBE Grid, CUBE Plancha, CUBE Board, CUBE Cover

☞ DDC Award 2019 Bronze
 Iconic Award "Innovative Interior" 2019 best of best
 dezeen awards 2019 longlisted
 Bayerischer Staatspreis 2017
 German Design Award Winner 2017
 Focus Open Design Award Winner 2017
 Design Plus Award Winner 2016
 Red Dot Design Award Winner 2016

☞ **CUBE Fire Basket black**
 43 x 43 x 44 cm, 15 kg | gross 47 x 47 x 52 cm, 17 kg
 Item No. 020101, EAN 4260447330122



CUBE OCEAN SET – Enjoy delicately grilled salmon over the aromatic flames of the fire. The fish fillet is securely fixed on the solid beechwood plank, attached to the CUBE, and grilled at the perfect angle over the flames.

- ☆ • All features of the CUBE Fire Basket black
- Includes flame-grilled salmon board
- Optional accessories: CUBE Grill Grid, CUBE Plancha, CUBE Board, CUBE Cover

☞ **CUBE Ocean Set**
 Fire basket: 43 x 43 x 44 cm, 15 kg | Packaging: 47 x 47 x 52 cm, 17 kg
 Flame-grilled salmon board: 55 x 14 x 5 cm, 1.6 kg |
 Packaging: 63.5 x 16 x 6 cm, 1.9 kg
 Item no. 00916, EAN 4064251009164



CUBE CORTEN STEEL – The visual alternative to the black CUBE. The effects of weathering create a unique, individual rust patina on the CUBE surface, making this version captivating with its unique rust look in addition to its usual functionality.

- ☆ • All features of the CUBE black
- Corten steel with lively, unique rust patina
- Optional accessories: CUBE Grid, CUBE Plancha, CUBE Board, CUBE Cover

☞ DDC Award 2019 Bronze
 Iconic Award "Innovative Interior" 2019 best of best
 dezeen awards 2019 longlisted
 Bayerischer Staatspreis 2017
 German Design Award Winner 2017
 Focus Open Design Award Winner 2017
 Design Plus Award Winner 2016
 Red Dot Design Award Winner 2016

☞ **CUBE Fire Basket Corten Steel**
 43 x 43 x 44 cm, 15 kg | gross 47 x 47 x 52 cm, 17 kg
 Item No. 020102, EAN 4260447330214



CUBE COVER – Fits like a tailored suit to keep CUBE secure. The water-repellent material protects against dirt, moisture and scratches.

- ☆ • Perfectly fitting protective cover
- Water-repellent
- Hard-wearing polyester-nylon blend fabric

☞ **CUBE Cover**
 44 x 44 x 44 cm, 0.5 kg | gross 26.5 x 29 cm, 0.8 kg
 Item No. 020402, EAN 4260447331013



CUBE FLIP SET – Fire basket and furniture in one, offering double the smart usage! Enjoy the warmth of the fire without worry, and when the fire basket has cooled down, simply snap the solid bamboo top into place, transforming CUBE into a practical piece of furniture.

- ☆ • All features of the CUBE fire basket black
- Includes CUBE bamboo board
- Optional accessories: CUBE Grill grid, CUBE Plancha, CUBE Cover

☞ **CUBE Flip Set**
 Fire basket: 43x43x44 cm, 15 kg | Packaging: 47x47x52cm, 17 kg
 Board: 42x42x3 cm, 3.5 kg | Packaging: 44x43x4 cm, 3.8 kg
 Item no. 00914, EAN 4064251009140



CUBE BOARD – With the solid bamboo board, the CUBE fire basket can be transformed into a pleasant seat, side table or flower stool with a flick of the wrist. The extraordinarily high surface hardness makes bamboo one of the most durable woods. Our additional lacquering makes it even more durable. Use only after CUBE has cooled down completely.

- ☆ • Transforms the fire basket into a stool or side table
- Can also be used as a serving tray
- Bamboo solid wood, 30 mm thick, UV-resistant lacquered

☞ **CUBE Board**
 42 x 42 x 3 cm, 3.5 kg | gross 44 x 43 x 4 cm, 3.8 kg
 Item No. 020201, EAN 4260447330146



CUBE BBQ SET – The CUBE BBQ Set fulfills all culinary needs, allowing you to enjoy the warmth of the fire while savoring grilled delicacies. Simply insert the grill grid into the notches around the rim of the CUBE at the desired height, and you're ready to grill.

- ☆ • All features of the CUBE fire basket black
- Includes CUBE Grill Grid
- Optional accessories: CUBE Plancha, CUBE Board, CUBE Cover

☞ **CUBE BBQ Set**
 Fire basket: 43x43x44 cm, 15 kg | Packaging: 47x47x52 cm, 17 kg
 Grill Grid: 41x41x10 cm, 1.6 kg | Packaging: 41x41x10 cm, 1.6 kg
 Item no. 00915, EAN 4064251009157

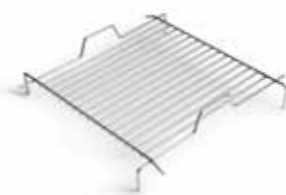

CUBE GRID – Thanks to the solid stainless steel grill grid, CUBE can also be used for grilling. The height of the grid can be adjusted thanks to the fire basket's cut-outs and thus the heat can be regulated.

- ☆ • Height-adjustable grid with Ø 6 mm bars
- Integrated handles for safe insertion
- Polished stainless steel

☞ **CUBE Grid**
 41 x 41 x 10 cm, 1.6 kg | gross 41 x 41 x 10 cm, 1.6 kg
 Item No. 020301, EAN 4260447330139



CUBE PLANCHA – Whether fish, meat or vegetables: with the solid, enamelled cast iron plate, CUBE turns into a plancha grill. The plancha offers a smooth and a ribbed surface and can be adjusted in height thereby adjusting the heat thanks to the fire basket's cut-outs. There is room for two planchas at the same time, at different heights if required.

- ☆ • Plancha with non-stick coating and good heat storage for low-fat cooking
- Different surfaces per side: smooth / ribbed
- Can be positioned at four different heights
- Two planchas possible in one CUBE
- Cast iron grid, enamelled

☞ **CUBE Plancha**
 50 x 28 x 3 cm, 3.2 kg | gross 52 x 30 x 4 cm, 3.5 kg
 Item No. 020501, EAN 4260447330283

TRIPLE 120 | 90 | 65



MATERIAL

Corten steel



CONDITION AS-DELIVERED



RUST PATINA develops over time

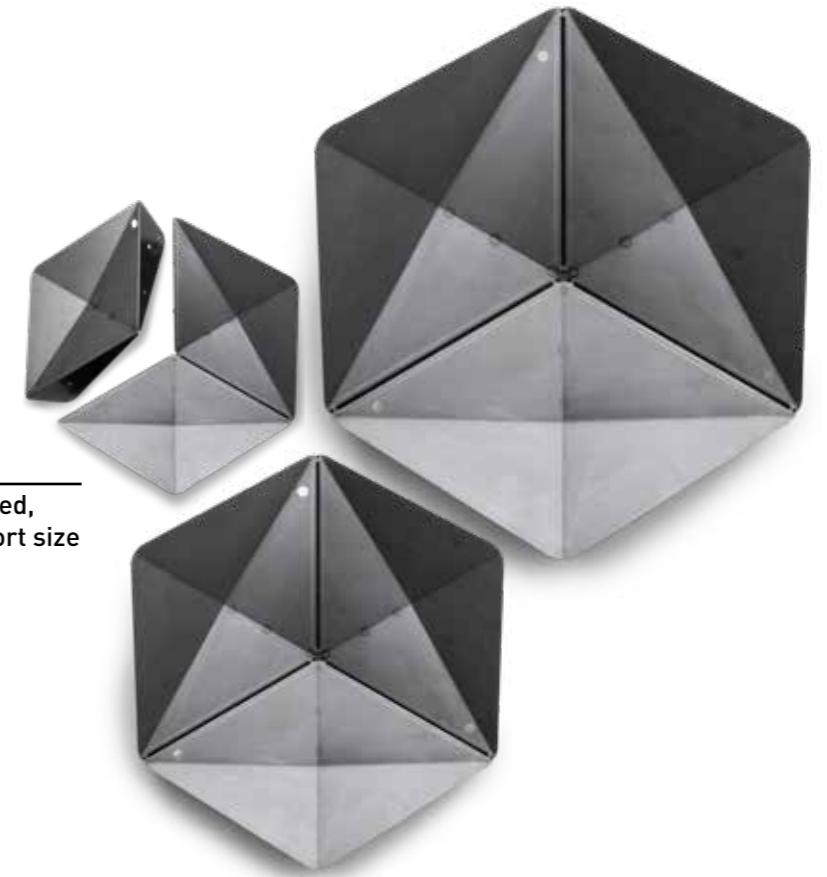

Can be dismantled,
compact transport size

TRIPLE

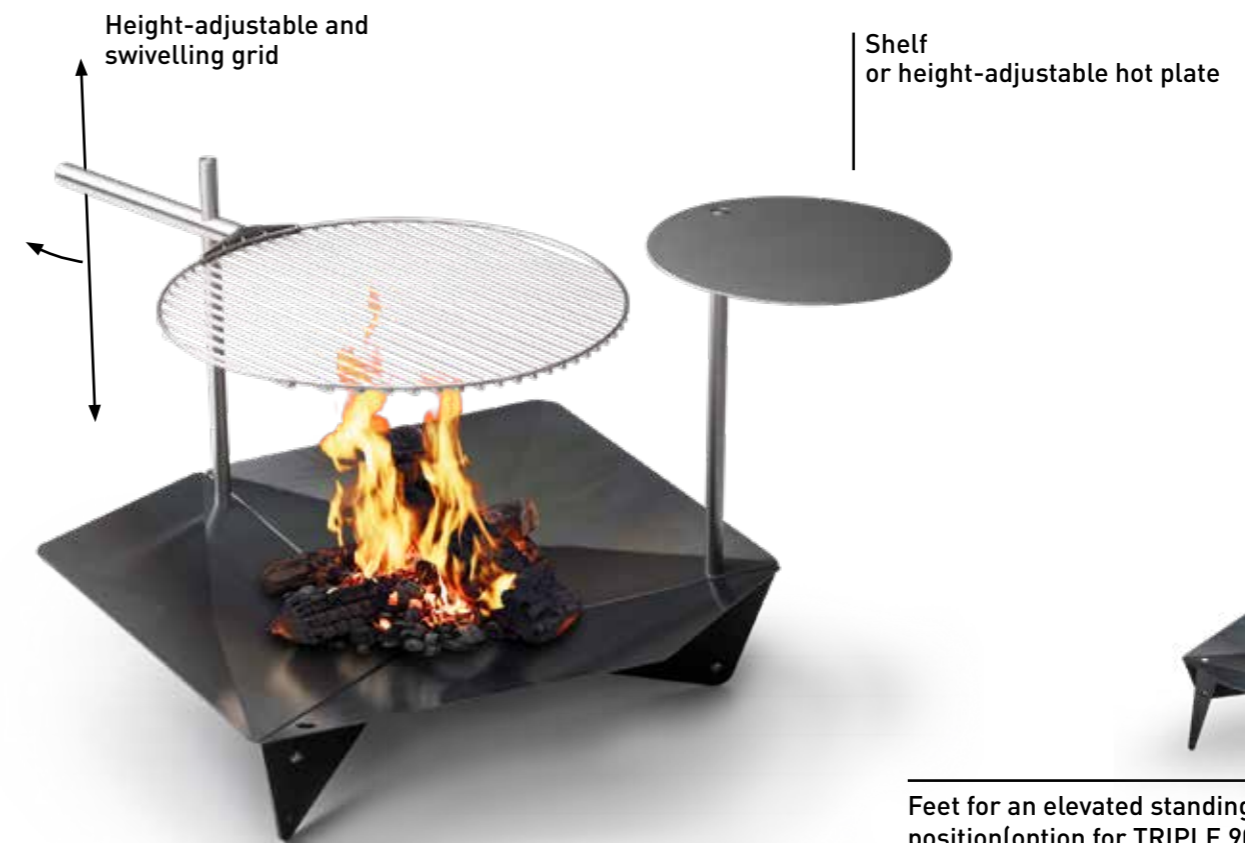

Feet for an elevated standing
position(option for TRIPLE 90)



TRIPLE – An homage to open fireplaces, interpreted with angular clarity in solid Corten steel. TRIPLE cultivates the archaic heat source through inspired simple functionality. Three identical, faceted segments fit together in a few simple steps to form a solid, large whole.

The fact that they can be dismantled allows for mobility and resource-saving transport. The adaptable grill grid is infinitely height-adjustable and swivels. There is space on the shelf for a pot of tea, mulled wine or grilled food, but it can also be swung inwards to cook a fiery stew.

- ☆ • Fire bowl with expandable grill function
- Easy to dismantle, compact transport size
- Optional accessories: infinitely height-adjustable and swivelling grill grid, shelf or height-adjustable hot plate
- Up to three accessory bars can be mounted (TRIPLE 120/90)
- Elevated standing position possible due to add-on feet (TRIPLE 90 only)
- Corten steel, it develops a lively, unique rust patina



TRIPLE GRID – The grid can be infinitely adjusted in height and swivelled. A vertical bar forms the guide, along which the grill grid can be adjusted vertically by 45 cm. It holds at any height by tilting.

- ☆ • Infinitely height-adjustable due to self-canting with the bar
- Swivelling
- Grid with Ø 6 mm bars
- Polished stainless steel grate, brushed stainless steel handle
- Incl. höfats TRIPLE pole (Item 050601 / 050602)

📏 **TRIPLE Grid 55 (suitable for TRIPLE 90 & 120)**
 Ø 55 cm, 4 kg | gross 55 × 55 × 3 cm, 4 kg
 Item No. 050302, EAN 4260447330467

📏 **TRIPLE Grid 45 (suitable for TRIPLE 65, 90 & 120)**
 Ø 45 cm, 3 kg | gross 45 × 45 × 3 cm, 3 kg
 Item No. 050301, EAN 4260447330450

🏆 European Product Design Award
 Iconic Award "Innovative Interior" 2019
 reddot design award 2018

📏 **TRIPLE 120 Fire Bowl**
 Ø 120 cm, height: 32 cm, 21.5 kg | gross 90 × 63 × 22 cm, 25 kg
 Item No. 050103, EAN 4260447330443,

📏 **TRIPLE 90 Fire Bowl**
 Ø 90 cm, height: 24 cm, 13 kg | gross 68 × 49 × 18 cm, 15.2 kg
 Item No. 050102, EAN 4260447330436,

📏 **TRIPLE 65 Fire Bowl**
 Ø 65 cm, height: 17 cm, 6.4 kg | gross 49 × 36 × 15 cm, 8.1 kg
 Item No. 050101, EAN 4260447330429



TRIPLE TABLE – There is room for a pot of tea, mulled wine or barbecue food on the storage surface, but it can also be swivelled inwards, lowered and a fiery stew cooked.

- ☆ • Shelf for barbecue utensils/drinks and hot plate for pots/pans
- Infinitely height-adjustable due to self-canting with the bar
- Swivelling
- Stainless steel, brushed
- Excl. höfats TRIPLE pole (Item 050601 / 050602)

📏 **TRIPLE Table**
 Ø 35 cm, 2.2 kg | gross 36 × 36 × 3 cm, 2.5 kg
 Item No. 050201, EAN 4260447330481



TRIPLE BBQ SET – The BBQ Set enhances the primal heat source with culinary functionality: The infinitely adjustable and swivelable grill grid allows for precise grilling over the open flame.

- ☆ • All features of the TRIPLE Fire Bowl
- Includes matching TRIPLE Grill Grid 45 (for TRIPLE 60) or TRIPLE Grill Grid 55 (for TRIPLE 90 and 120)

📏 **TRIPLE 120 BBQ Set**
 Fire bowl Ø 120 cm, height: 32 cm, 21.5 kg | Packaging: 90×63×22 cm, 25 kg
 Grill grid Ø 55 cm, 4 kg | Packaging: 55 × 55 × 3 cm, 4 kg
 Item no. 00995, EAN 4064251009959

📏 **TRIPLE 90 BBQ Set**
 Fire bowl Ø 90 cm, height: 24 cm, 13 kg | Packaging: 68×49×18 cm, 15.2 kg
 Grill grid Ø 55 cm, 4 kg | Packaging: 55 × 55 × 3 cm, 4 kg
 Item no. 00993, EAN 4064251009935

📏 **TRIPLE 65 BBQ Set**
 Fire bowl Ø 65 cm, height: 17 cm, 6.4 kg | Packaging: 49 × 36 × 15 cm, 8.1 kg
 Grill grid Ø 45 cm, 3 kg | Packaging: 45 × 45 × 3 cm, 3 kg
 Item no. 00991, EAN 4064251009911



TRIPLE POLE – If the TRIPLE Table is not to be placed on the same vertical pole of the grid, TRIPLE Pole gives it its own mounting.

- ☆ • Mounting for table/grid
- Up to three accessory bars can be mounted (TRIPLE 120 | 90)
- Stainless steel, brushed

📏 **TRIPLE Pole 55 (suitable for TRIPLE 90 & 120)**
 Ø 2 cm, 55 cm length, 0.6 kg | gross 56 × 2 × 2 cm, 0.6 kg
 Item No. 050602, EAN 4260447330641

📏 **TRIPLE Pole 40 (suitable for TRIPLE 65, 90 & 120)**
 Ø 2 cm, 40 cm length, 0.5 kg | gross 43 × 2 × 2 cm, 0.5 kg
 Item no. 050601, EAN 4260447330634



TRIPLE MULTI SET – The multi-set offers maximum versatility and transforms the fire pit into a fully equipped outdoor cooking and enjoyment station.

- ☆ • All features of the TRIPLE Fire Bowl
- Includes matching TRIPLE Grill Grid 45 (for TRIPLE 60) or TRIPLE Grill Grid 55 (for TRIPLE 90 and 120) and TRIPLE Table
- Includes additional TRIPLE Pole 40 for TRIPLE 90 and 120

📏 **TRIPLE 120 Multi Set**
 Fire bowl Ø 120 cm, height: 32 cm, 21.5 kg | Packaging: 90×63×22 cm, 25 kg
 Grill grid Ø 55 cm, 4 kg | Packaging: 55 × 55 × 3 cm, 4 kg
 Table Ø 35 cm, 2.2 kg | Packaging: 36 × 36 × 3 cm, 2.5 kg
 Pole Ø 2 cm, length 40 cm, 0.5 kg | Packaging: 43 × 2 × 2 cm, 0.5 kg
 Item no. 00996, EAN 4064251009966

📏 **TRIPLE 90 Multi Set**
 Fire bowl Ø 90 cm, height: 24 cm, 13 kg | Packaging: 68×49×18 cm, 15.2 kg
 Grill grid Ø 55 cm, 4 kg | Packaging: 55 × 55 × 3 cm, 4 kg
 Table Ø 35 cm, 2.2 kg | Packaging: 36 × 36 × 3 cm, 2.5 kg
 Pole Ø 2 cm, length 40 cm, 0.5 kg | Packaging: 43 × 2 × 2 cm, 0.5 kg
 Item no. 00994, EAN 4064251009942

📏 **TRIPLE 65 Multi Set**
 Fire bowl Ø 65 cm, height: 17 cm, 6.4 kg | Packaging: 49 × 36 × 15 cm, 8.1 kg
 Grill grid Ø 45 cm, 3 kg | Packaging: 45 × 45 × 3 cm, 3 kg
 Table Ø 35 cm, 2.2 kg | Packaging: 36 × 36 × 3 cm, 2.5 kg
 Item no. 00992, EAN 4064251009928



TRIPLE 90 FEET – To give TRIPLE 90 a higher standing position, additional feet can be mounted. This is helpful to achieve an ergonomic grill height or to protect the ground from too much heat. When the feet are not needed at the moment, they can simply be swung inwards.

- ☆ • Elevating feet for TRIPLE 90
- Raises the fire bowl by 20 cm
- Easy assembly, three parts
- Feet fold inwards
- Corten steel

📏 **TRIPLE 65 Feet**
 34 × 9 × 0.4 cm, 1.8 kg | gross 34 × 9 × 1 cm, 1.8 kg
 Item No. 050501, EAN 4260447330498



3

VENEZIA
SINCE 1971

VENEZIA
SINCE 1971

BEER BOX

BEER BOX



MATERIAL

Corten steel



BEER BOX – The evolution of the beverage crate begins with the materials wood and metal and ends for the time being with plastic for economic reasons. But what if there is a life after its existence as a beverage container, if the crate is upcycled into a fire basket after its initial use? BEER BOX, a fire basket made of solid Corten steel in its simplest form, yet amazingly versatile: The large handles cry out for mobility - so off you go outside! The cardboard interior is also a firelighting material.

Thanks to accessories, the box becomes a barbecue or stool and the ability to stack makes sense for raising the fire basket as well as for storage and transport. The fact that the box is also an ideal advertising medium is in the nature of things and the integrated bottle top opener is simply a joy!

- ☆ Beverage crate and fire basket with optional extension to barbecue and stool
- Integrated bottle opener
- Incl. cardboard inlay for bottles 0.33l
- Stackable with another BEER BOX or standard beverage crate
- Optional accessories: BEER BOX Grid, BEER BOX Board
- Corten steel, it develops a lively, unique rust patina

🕒 European Product Design Award
Stahl-Innovationspreis 2018
Focus Open 2018

📦 **BEER BOX Fire Basket**
38 x 28 x 30 cm, 7 kg | gross 40 x 32 x 31 cm, 9,5 kg
Item No. 070101, EAN 4260447330504



BEER BOX BOARD – The board allows the BEER BOX fire basket to be transformed into a comfortable seat, side table or flower stool in one easy step.

- ☆ Turns the BEER BOX into a stool or side table
- Can be used as a serving tray, all-round juice groove on the back
- Bamboo solid wood, sealed with clear lacquer

📦 **BEER BOX Board**
40 x 30 x 2,5 cm, 1,5 kg | gross 40 x 30 x 2,5 cm, 1,5 kg
Item No. 070201, EAN 4260447330580

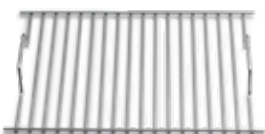

BEER BOX GRID – The stainless steel grill grid also allows grilling on the BEER BOX. Thanks to handles, it is easy to put on or take off.

- ☆ Grill grid with Ø 5 mm bars
- Integrated handles for safe insertion
- Polished stainless steel

📦 **BEER BOX Grid**
42 x 30 x 4 cm, 0,9 kg | gross 42 x 30 x 4 cm, 0,9 kg
Item No. 070301, EAN 4260447330511

CRATE

MATERIAL

Corten steel



CRATE – CRATE follows in the footsteps of the legendary BEER BOX. While the beer crate was the source of inspiration for the BEER BOX, CRATE is reminiscent of wine and fruit crates. The usual material of wood is replaced by high-quality Corten steel. The result is a multifunctional product that can be many things: Wood storage, wine, beer or fruit crate, but also fire basket, stool and barbecue.

A spontaneous trip to the lake? CRATE is the perfect companion! In addition to drinks, the robust box can also be used to transport firewood for an atmospheric campfire or a small barbecue - and the grill grid comes along!

- ☆ Fire basket with optional extension to grill and stool
- Can also be used as a beverage crate, wine crate, beer crate, wood storage, fruit crate, etc.
- Stackable with another CRATE
- Durable stainless steel riveting
- Optional accessories: CRATE Grid, CRATE Board
- Corten steel, it develops a lively, unique rust patina

📦 **CRATE Fire Basket**
40 x 30 x 27 cm, 6,6 kg | gross 42 x 32 x 30 cm, 8,8 kg
Item No. 120101, EAN 4260447330863



CRATE BOARD – The board allows CRATE to be transformed into a comfortable seat, side table or flower stool in one easy step.

- ☆ Turns the fire basket into a stool or side table
- Can be used as a serving board, solid bamboo wood, 15 mm thick, UV-resistant lacquered

📦 **CRATE Board**
39 x 29 x 1,5 cm, 1 kg | gross 39 x 29 x 1,5 cm, 1 kg
Item No. 120201, EAN 4260447330870



CRATE GRID – Simply place the grill grid made of chrome-plated steel on the fire basket and there is plenty of room for all kinds of tasty treats.

- ☆ Grill grid with Ø 5 mm bars
- Chrome-plated steel

📦 **CRATE Grid**
38 x 29 x 1 cm, 0,9 kg | gross 38 x 29 x 1 cm, 0,9 kg
Item No. 120301, EAN 4260447330887

INDIVIDUAL BRANDING S. 74

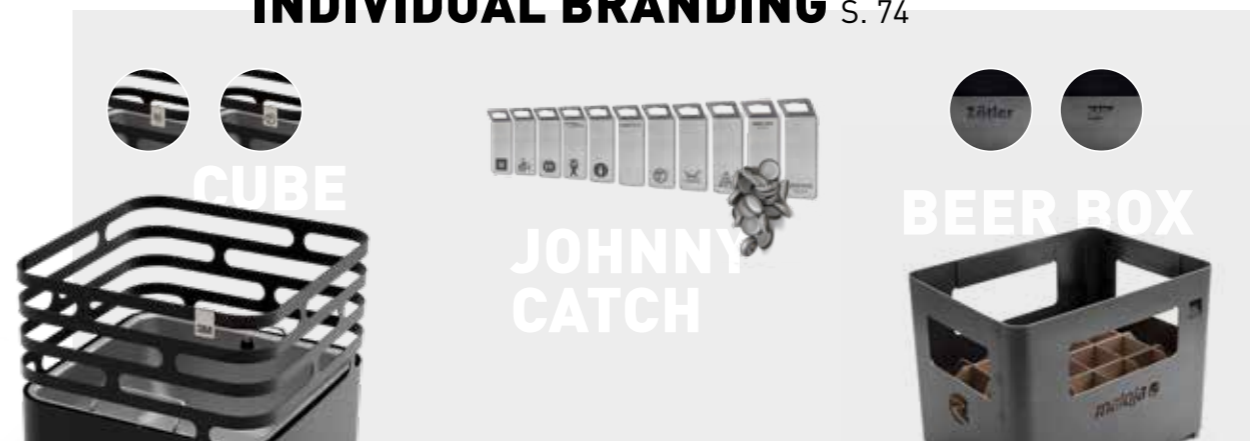

ELLIPSE



MATERIAL

Corten steel



CONDITION AS-DELIVERED



RUST PATINA
develops over time



ELLIPSE



ELLIPSE – A sculptural fire bowl made of Corten steel that surprises with unexpected functionality. It can take up a neutral position, but can also be turned towards a seating group or shield the flames from too much wind.

The foot provides stability and serves as a stand for the rounded shell. It also serves as an ash tray: when the fire has mostly burned down and is to be fully extinguished, the tray can be emptied into the foot by tilting it to one side. The foot is then closed with the empty fire bowl in the overhead position, which smothers the remaining fire and prevents sparks from flying.

- ☆ • Fire bowl with expandable grill function
- Swivelling fire bowl: neutral and tilted position
- Finish safely & cleanly: embers can be emptied into the foot, fire bowl covers foot
- Optional accessories: ELLIPSE Grid, ELLIPSE Foot for elevated standing position
- Corten steel, it develops a lively, unique rust patina

archiproducts design award 2018

ELLIPSE Fire Bowl
110×57×36 cm, 17.5 kg | gross 114×60×21 cm, 19.5 kg
Item No. 060101, EAN 4260447330528



ELLIPSE GRILL – The solid stainless steel grill grid enables ELLIPSE to be used for barbecuing. The grid can hold food to 5kg. The heat can be increased by pushing more embers under the grid or reduced by moving them to the side.

- ☆ • Grill grid with Ø 6 mm bars
- Grid is simply hooked onto the edge, no further assembly necessary
- Polished stainless steel

ELLIPSE Grid
60×40×7 cm, 3 kg | gross 60×40×7 cm, 3 kg
Item No. 060301, EAN 4260447330535



ELLIPSE FOOT – To give ELLIPSE an elevated stand, the foot can be attached to an additional foot element. This is helpful to achieve an ergonomic grill height, or to protect the ground from too much heat. Up to two additional foot elements are useful.

- ☆ • Additional foot element for increased stability
- Simple plug-in assembly
- Allows fire bowl to be raised by 18 cm at a time
- Use a maximum of 2 additional foot elements
- Corten steel

ELLIPSE Foot
Ø 35 cm, 18 cm height, 4,6 kg | gross 36×36×22 cm, 6,3 kg
Item No. 060501, EAN 4260447330542

FIRE TOOLS S. 65



Fire Tool Set

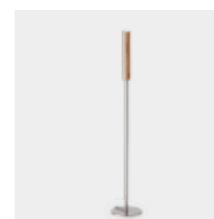

Blow poker with stainless steel base



Blow poker



Fire Tongs



CONE



CONE



MATERIAL

100% stainless steel, powder-coated

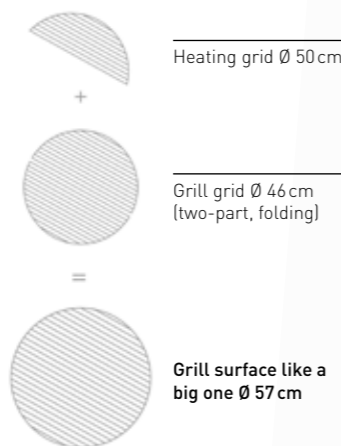

Comfortable working height 85 cm

100% stainless steel

With the lid closed or half-closed, even larger grilled food can be cooked slowly and energy-efficiently. Just like in an oven, the heat reaches the food from all sides.

stepless & instant heat regulation

The distance between the charcoal and the food to be grilled is minimal, the air supply is open to the maximum
= maximum possible heat

The distance between the charcoal and the food is average, the air supply is open
= medium heat

The distance between the charcoal and the food to be grilled is maximum, the air supply is closed
= least heat

fire basket function



CONE – Is the first charcoal grill with effective heat regulation. It transfers the comfort of a gas barbecue to a charcoal grill and enables intuitive heat regulation by controlling the distance between the heat source and the food to be grilled via the air supply.

If high heat is required, for example for a hot barbecue, the charcoal grate and thus the heat source is raised. To reduce the heat, the grate is lowered and the air supply is automatically reduced. Since the charcoal grate can be raised to the edge of the funnel, CONE can be converted into a fireplace after grilling.

CONE MOUNTING – For those who are keen on an outdoor kitchen, the CONE mounting offers the ideal solution, as it can be embedded in a wooden, concrete or stone tabletop. The table is not included in the scope of delivery, but a mounting ring for mounting on the table is.

CONE BOARD – To keep the cool drink always to hand and to place the grilled food directly next to the grid until it is put on. The board is docked onto the barbecue in one easy step and removed just as quickly. Bamboo is one of the most durable woods thanks to its exceptionally high surface hardness and also contains a natural antibacterial agent, making it the perfect material for a cutting board.

CONE CAST IRON GRID – More than just a cast iron grid. The drip tray, specially developed for the extremely solid grid, makes charcoal grilling healthier than ever before - it ensures that no fat or marinade can drip into the embers, but the food still takes on the woody smoky note of the charcoal.

The cast iron grid comes in two parts, each with a drip tray, and can be folded - as expected from CONE.

CONE COVER – Fits like a tailored suit. The water-repellent material in combination with a high-tech outdoor zip protects CONE like a second skin against dirt and moisture, even when it is put into hibernation in autumn. The integrated carrying handles make CONE comfortable to transport.

- ☆ Charcoal grill with infinitely variable heat regulation
- Can also be used as a fire basket
- Solid grid: Ø 46 cm, Ø 5 mm bars, polished stainless steel
- Incl. warming grid (Ø 50 cm segment)
- Incl. lid thermometer and 2 hooks for hanging barbecue tools
- Completely made of stainless steel
- Optional accessories: CONE Board, CONE Cast Iron Grid

- 🏆 European Product Design Award
- 🏆 German Design Award Winner 2017
- 🏆 iF Design Award Winner 2016
- 🏆 Red Dot Design Award Winner 2015
- 🏆 Focus Open Design Award Winner 2015

📦 **CONE Charcoal Grill**
60 × 60 × 105 cm, 17 kg | gross 60 × 60 × 111 cm, 25 kg
Item No. 010101, EAN 4260447330030

- ☆ All features of the CONE Grill
- Installation kit for recessing in all worktops
- Stainless steel

📦 **CONE Mounting**
Mounting ring Ø 60, height 5 cm, CONE height 90 cm, 17 kg
gross 60 × 60 × 111 cm, 25 kg
Item No. 010501, EAN 4260447330078

- ☆ Storage and serving tray
- All-round juice groove
- Incl. 2 mountings
- Easy assembly
- Bamboo solid wood, food-safe oiled

📦 **CONE Board**
40 × 31 × 2 cm, 1.5 kg | gross 42 × 32 × 5 cm, 2.3 kg
Item No. 010201, EAN 4260447330061

- ☆ Anti-flame function
- Good heat storage
- Unique branding
- Flavourising function
- Stainless steel drip tray
- Cast iron grid, enamelled

📦 **CONE Cast Iron Grid**
Ø 46 cm, thickness 2 cm, 6 kg | gross 47 × 24 × 7 cm, 6.5 kg
Item No. 010301, EAN 4260447330054

- ☆ Perfectly fitting protective cover
- Water-repellent
- Integrated handles
- High quality outdoor zip
- Hard-wearing polyester-nylon blend fabric

📦 **CONE Cover**
42 × 32 × 5 cm, 0.6 kg | gross 26 × 42 cm, 0.8 kg
Item No. 010401, EAN 4260447330047

TOOLS



ambiente
solutions
2023



BARBECUE TONGS – Thanks to their asymmetrical shape, they lie ergonomically and securely in the hand. The slightly slanted flanks also allow delicate goods to be gripped gently. Cut-outs at the ends provide grip and visibility – they give the tongs transparency in the area of action, making them the perfect tool for small prawns as well as T-bone steaks. The clue: With these tongs, the grid can be lifted and positioned over the embers.

SCRAPER – When grilling on the plancha, the scraper is essential. Inspired by the Japanese art of Teppanyaki grilling, there is no food that the scraper cannot assist with. Turning, cutting and stirring are among its specialities and it is even at your service when cleaning the plancha. During barbecue breaks, the scraper can be hung securely on a hook on the fire bowl, on the barbecue or in the kitchen and is always ready for its next use.

SPATULA – It unfolds its full potential when used on the grid. It turns larger as well as fragile grilled food to allow all sides to feel the heat of the fire. Thanks to its flexible handling and ergonomic design, the spatula is also helpful when cutting up and mixing grilled food right on the plancha. During barbecue breaks, it can be hung securely on a hook on the fire bowl, on the barbecue or in the kitchen, so it is always ready for its next culinary mission.

BBQ STARTER – It can be used like a classic kindling chimney, but also according to the höfats kindling principle, where the kindling chimney does not have to be turned upside down, but is simply pulled off upwards. There are no sparks or ash flying compared to conventional kindling stoves, making it far safer and more convenient.

FIRE TOOL SET – With the complete set consisting of fire tongs, blow poker and wooden base, the fire is under control. The blow poker does justice to its task of stoking the fire in two senses, because the fire can also be lit at a safe distance from the flames via the inconspicuous, integrated flame blower tube. With the robust fire tongs made of solid stainless steel, even heavy and burning logs can be lifted effortlessly and larger barbecued food turned thanks to strong serrations. Both together snap harmoniously into the weighted wooden base which makes the set easy to lift on the fire tongs and mobile for use on the fire bowl, stove and fireplace.

BLOW POKER ON STAINLESS STEEL BASE – The blow poker does justice to its task of stoking the fire in two senses, as it makes it possible to additionally start the fire at a safe distance from the flames via the inconspicuous, integrated flame blower tube. This very tube also makes it possible to place the poker upright on the stainless steel base and store it safely – for lasting enjoyment of the fire.

BLOW POKER – The poker does justice to its task of stoking the fire in two senses, as it makes it possible to additionally start the fire at a safe distance from the flames via the inconspicuous, integrated flame blower tube.

FIRE TONGS – Even burning logs stay firmly in your hand with the robust fire tongs made of solid stainless steel. The strong serrations allow a secure grip to lift firewood or to turn larger grilled food. For storage, the fire tongs can effortlessly snap into the weighted wooden base (accessory) and be used in a mobile way on the fire bowl, stove or fireplace.



- Ergonomically shaped grill tongs with grid lifter function
- Perfect length
- Cut-outs at the ends provide better grip and visibility
- Stainless steel



- Flexible scraper for food preparation and cleaning the plancha
- Ergonomic handle for non-slip grip
- Material cut-out for hanging
- Suitable for easy cleaning in the dishwasher
- Stainless steel



- Flexible spatula for food preparation and cleaning the plancha
- Ergonomic handle for non-slip grip
- Material cut-out for hanging
- Suitable for easy cleaning in the dishwasher
- Stainless steel



- Ignition chimney for comfortable, safe and fast ignition
- höfats kindling principle: empty the glowing charcoal without turning it over
- Handle becomes hand-warm at most
- 2.5 kg capacity
- Stainless steel



- Three-piece complete set: fire tongs, blow poker and wooden base
- Ideal for höfats fire bowls & fire baskets or as fireplace set
- Blow poker: stainless steel with oak handle, stainless steel mouthpiece
- Fire tongs: stainless steel, dishwasher safe.
- Wooden base: ash



- Poker with integrated flame blower for easy and safe lighting of the fire
- Ideal for höfats fire bowls & fire baskets or as fireplace set
- Poker can be easily placed on the stainless steel base via the flame blower tube
- Stainless steel with oak handle, stainless steel mouthpiece



- Poker with integrated flame blower for easy and safe lighting of the fire
- Ideal for höfats fire bowls & fire baskets or as fireplace set
- Stainless steel with oak handle, stainless steel mouthpiece
- Optional accessories: wooden or stainless steel base for vertical storage



- Safe handling of firewood thanks to strong serration at the end of the tongs
- Also ideal for use as barbecue tongs for heavy barbecued food
- Ideal for höfats fire bowls & fire baskets or as fireplace set
- Stainless steel, dishwasher safe
- Optional accessories: wooden base for storing and transporting the fire tongs



Focus Open Design Award Winner 2016
iF Design Award Winner 2016



40 x 7 x 2 cm, 0.2 kg |
gross 43 x 9 x 3 cm, 0.31 kg

Barbecue Tongs silver
Item No. 030402, EAN 4260447330658
Barbecue Tongs black
Item No. 00859, EAN 4064251008594



26 x 11 x 2.5 cm, 0.15 kg |
gross 28.5 x 12.5 x 3.5 cm, 0.25 kg

Scraper silver
Item No. 00472, EAN 4064251004732
Scraper black
Item No. 00857, EAN 4064251008570



29 x 9 x 5 cm, 0.15 kg |
gross 30.5 x 10.5 x 5.5 cm, 0.23 kg

Spatula silver
Item No. 00473, EAN 4064251004732
Spatula black
Item No. 00858, EAN 4064251008587



BBQ Starter
Ø 19 cm, 31 cm height, 1.3 kg |
gross 32 x 29 x 19.5 cm, 4.7 kg
Item No. 030102, EAN 4003739218018



Fire Tool Set (3pcs)
8 x 8 x 60 cm, 1 kg |
gross 9 x 9 x 63 cm, 1.32 kg
Item No. 00251, EAN 4064251002516



Blow Poker on Stainless Steel Base
10 x 10 x 59 cm, 0.46 kg |
gross 59.5 x 11.5 x 3 cm, 0.62 kg
Item No. 00252, EAN 4064251002523



Blow Poker
58 x 6 x 2.2 cm, 0.17 kg |
gross 59.5 x 7.0 x 3.0 cm, 0.28 kg
Item No. 00581, EAN 4064251005814



Fire Tongs
50 x 11 x 2.7 cm, 0.4 kg |
gross 51.5 x 11.5 x 3.5 cm, 0.55 kg
Item No. 00253, EAN 4064251002530

TOOLS



DESIGN PLUS
Winner 2016



STEAK TOOLS – This is a tool that does justice to a perfect piece of meat. The sharp blade does not tear the meat fibres, but cuts them precisely, which keeps the meat juicy and aromatic. Solid, forged from one piece, the brushed, satin-matt stainless steel lies firmly and perfectly balanced in the hand. Stainless, dishwasher-safe and form-stable, the höfats steak tools are indestructible and guarantee years of enjoyment of good meat. High quality packaged in a wooden box, they are the perfect gift for any meat lover and anyone who appreciates good food. By the way, the höfats Steak Tools also perform with Pizza.

APRON – The sophisticated höfats apron turns you and your barbecue and cooking skills into a winning team. Its robust and easy-care material is tailor-made for you, because thanks to the continuous cord that runs from the neck over the sides to the hips, the apron can be adjusted to the body size with just one movement. This makes it fit perfectly right away and offers maximum wearing comfort. The simple integrated pocket and the towel strap are delightful. It comes already equipped with a high-quality linen towel.

FIRE GLOVES LEATHER – The robust höfats barbecue gloves made of pure, heavy suede and Kevlar are hand-sewn and made to last. They are extremely non-slip and heat-resistant and make barbecuing a safe pleasure, not least thanks to the extremely pleasant inner lining.

FIRE GLOVES ARAMID – As snug as a second skin and heat-resistant up to 500°C. Breathable aramid fibre is the special material of these fire gloves, which allow you to safely handle extremely hot objects. The silicone nubs on the entire palm ensure that you can grip even delicate objects reliably.

FLAME-GRILLED SALMON BOARD The Finnish classic offers space for any fish and adds its unique flavour above the aromatic flames of the fire. The fish fillet is securely fixed under the stainless steel support on the solid beech wood board and can be attached to any höfats fire bowl or basket. To ensure that the fish is cooked evenly and gently, the flame-grilled salmon board fits into the mount from both sides and the different angles of inclination between the board and the flames guarantee optimum temperature handling.

JOHNNY CATCH – The probably best wall bottle opener in the world catches bottle caps magnetically or in a catch cup! 100% stainless steel. Johnny Catch does not need screws or dowels, it is mounted on the wall with a high-quality double-sided adhesive tape from 3M. The adhesive tape adheres to all surfaces, even very uneven ones.

Johnny Catch is a must: for the style-conscious beer drinker, lemonade lover, craft beer crack, in the pub around the corner, clubhouse, band room, club, music sports hall, construction trailer, bling bling club, in your favourite bar, kebab stand, gazebo, Stylo kitchen, chaos flat-share, party shed, ski hut, beach bar, workshop, on the roof terrace, next to your barbecue, fridge... Cheers!

- ☆ Very solid and perfectly balanced
- ☆ Extremely sharp blade with serrated edge
- ☆ Forged from a single piece
- ☆ High-quality packaging in wooden box
- ☆ Satin brushed stainless steel

- ☆ Barbecue apron with continuous cord
- ☆ Adapts to any body size
- ☆ Integrated pocket and cloth strap
- ☆ Incl. 100% linen towel
- ☆ Easy-care, robust cotton blend fabric
- ☆ Washable (without cord) 40°C
- ☆ High-quality mountain rope

- ☆ Heat resistant up to 350°C
- ☆ High wearing comfort, extremely good grip
- ☆ Long forearm protection with 15 cm length
- ☆ Ideal for use at the barbecue, fireplace, oven etc.
- ☆ Outer material: 100% natural leather
- ☆ Lining: cotton
- ☆ Integrated cotton loop to hang up the gloves
- ☆ Certified according to PSA Category 2, EN 388, EN 407
- ☆ 1 pair

- ☆ Heat resistant up to 500°C
- ☆ High wearing comfort, extremely good grip
- ☆ Long forearm protection with 13 cm length
- ☆ Ideal for use at the barbecue, fireplace, oven etc.
- ☆ Outer material: Aramid fibre
- ☆ Lining: Polycotton, 50% cotton, 50% polyester
- ☆ Heat-resistant silicone nubs on the outside for better grip
- ☆ Integrated cotton loop for hanging the gloves
- ☆ Certified according to PPE Category 2, EN 388, EN 407
- ☆ 1 pair

4x steak knife
4x steak fork
1x wooden box

Focus Open Design Award Winner 2016
Design Plus Award Winner 2016

Fire Gloves Leather
35 x 17 x 2 cm, 0.35 kg | gross 35 x 22 x 5 cm, 0.6 kg
Item No. 030302, EAN 4260447330672

Fire Gloves Aramid
33 x 16 x 1.5 cm, 0.2 kg | gross 36 x 23 x 2.5 cm, 0.25 kg
Item No. 00715, EAN 4064251007153,

Steak Tools
25 x 17 x 5 cm, 1 kg | gross 25 x 17 x 5 cm, 1 kg
Item No. 030501, EAN 4260447330252

Apron
77 x 66 cm, 0.4 kg | gross 35 x 22 x 5 cm, 0.6 kg
Item No. 030201, EAN 4260447330160

- ☆ Beech board with mount for preparing fish over the flames
- ☆ Suitable for all höfats fire bowls and fire baskets
- ☆ Adjustable angle between board and flame
- ☆ Board can be placed on the rack from both directions and used from both sides
- ☆ Wooden board: untreated beech wood
- ☆ Rack: solid stainless steel

Flame-grilled Salmon Board
55 x 14 x 5 cm, 1.58 kg | gross 63.5 x 15.5 x 5.5 cm, 1.85 kg
Item No. 00702, EAN 4064251007023

- ☆ Wall-mounted bottle opener with catch cup
- ☆ Holds approx. 60 bottle caps
- ☆ Mounting without screws, instead with extra-strong adhesive tape, holds even on rough surfaces
- ☆ Opener in brushed stainless steel
- ☆ Collecting cup in "soft touch" design (polypropylene)
- ☆ Wall-mounted bottle opener with magnet
- ☆ Very strong magnet, holds up to 20 bottle caps
- ☆ Mounting without screws, instead with extra-strong adhesive tape, holds even on rough surfaces
- ☆ Extremely flat to the wall
- ☆ Brushed stainless steel

European Product Design Award
Red Dot Design Award Winner 2015
FORM# 2014 Winner

European Product Design Award
Red Dot Design Award Winner 2015
FORM# 2014 Winner

23 x 12 x 6 cm, 0.25 kg
gross 27 x 15 x 6 cm, 0.31 kg

13 x 4 x 3 cm, 0.1 kg
gross 17 x 9 x 6 cm, 0.21 kg

JOHNNY CATCH Cup silver
Item No. 040201, EAN 4260447330023
JOHNNY CATCH Cup black
Item No. 00842, EAN 4064251008426

JOHNNY CATCH Magnet silver
Item No. 040101, EAN 4260447330016
JOHNNY CATCH Magnet black
Item No. 00841, EAN 4064251008419

OUR PRODUCTS WITH YOUR LOGO

Our products create a spark. They are gifts that people talk about, remember and want. They impress with their purist design, uncompromising workmanship and fascinating functionality. With the addition of laser engraving or laser cutting, your personalisation becomes permanent – the ideal gift for your valued employees or customers.



"FUNCTIONAL DESIGN MEETS ATTENTION TO DETAIL"

The WirtschaftsWoche headlined an article about höfats



CUSTOMER FEEDBACK

- **Over 50%** of all höfats products are given as **gifts to friends & family**.
 - **87%** of our customers are interested in at least one **other product from the höfats range**.
 - **97%** of our customers would recommend höfats to others without **hesitation**.
- [Customer survey July 2022, n = 3,027]

exclusive distributor for Adria region



HR-10360 Sesevete - Zagreb • Croatia
t: +385 1 3778 503 • e: haby@haby.hr

WWW.HABYOUTDOOR.COM

With fire and passion, we create fascinating products from uncompromising material - that is höfats - a fire story - our way of thinking and developing products, creating an unmistakable identity through puristic form and inspiring function. Always with perfection down to the last detail, so that a great idea becomes an authentic höfats product. A product for uniquely beautiful moments - experience your very own fire story.

höfats